

W E L C O M E  
GUIDE



BRITISH BROADCASTING CORPORATION  
MICROCOMPUTER SYSTEM 





# W E L C O M E G U I D E

The product described in this guide is the property of Acorn Computers Limited. All information in this guide is given by Acorn Computers Limited in good faith. However, Acorn Computers Limited does not accept any liability for errors or omissions in this guide or in the products it describes. A list of details of any amendments or revisions to this guide can be obtained on request from Acorn Computers. Acorn Computers welcomes comments and suggestions relating to this guide.

All maintenance and service work should be carried out by a qualified electrician. The information contained in this guide is intended to assist you in the safe use of the product. It does not constitute a warranty or a guarantee of any kind. Acorn Computers Limited shall not be liable for any loss or damage, including consequential loss or damage, arising from the use of the product, or from any error or omission in this guide, or any other document published by Acorn Computers.

## WARNING: THIS COMPUTER

Important: The wires in the mains lead are coloured as follows:  
Green and yellow Earth  
Blue Neutral  
Brown Live

### For United Kingdom users

The modified plug must be used with the appropriate socket outlet. It is not necessarily the same shade of that colour. The plug is not interchangeable. In the event of a fault, the plug must be replaced by another conventional plug wired as described. In the event of the fuse blowing, the plug must be replaced by another of the same rating.

### For all users

If the socket outlet available is not suitable for the plug, the appropriate plug must be used. It is not safe to use a plug which does not fit the socket outlet. It is a fire hazard if it is plugged into a socket outlet which is not suitable for the plug.

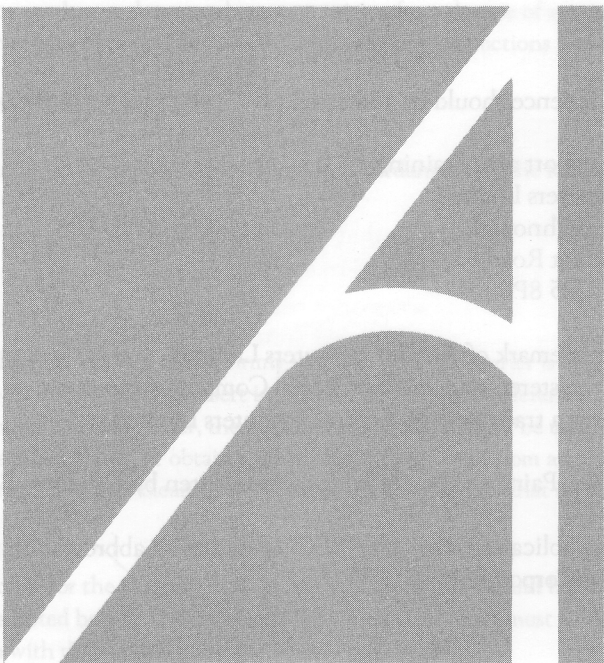

BRITISH BROADCASTING CORPORATION  
MICROCOMPUTER SYSTEM



# Archimedes

Designed, and laser-typeset by Human-Computer Interface Limited, Cambridge.

Copyright © Acorn Computers Limited 1987

Neither the whole nor any part of the information contained in, or the product described in, this guide may be adapted or reproduced in any material form except with the prior written approval of Acorn Computers Limited (Acorn Computers).

All correspondence should be addressed to:

Customer Support and Training,  
Acorn Computers Limited,  
Cambridge Technopark,  
645 Newmarket Road,  
Cambridge CB5 8PB.

Acorn is a trademark of Acorn Computers Limited.  
Econet is a registered trademark of Acorn Computers Limited.  
Archimedes is a trademark of Acorn Computers Limited.

Font Designer, Paint and Music Editor were written by Ashdown Software Ltd.

Within this publication, the term 'BBC' is used as an abbreviation for 'British Broadcasting Corporation'.

First published 1987  
Issue 3  
Published by Acorn Computers Limited  
Part number 0476.000

The product described in this guide and products for use with it are subject to continuous development and improvement. All information of a technical nature and particulars of the product and its use (including the information and particulars in this guide) are given by Acorn Computers Limited in good faith. However, it is acknowledged that there may be errors or omissions in this guide or in the products it describes. A list of details of any amendments or revisions to this guide can be obtained on request from Acorn Computers. Acorn Computers welcomes comments and suggestions relating to the product and this guide.

All maintenance and service on the product must be carried out by Acorn Computers' authorised dealers, or through an Acorn Computers' approved maintenance/repair agreement. Acorn Computers can accept no liability whatsoever for any loss or damage caused by service, maintenance or repair by unauthorised personnel. This guide is intended only to assist the reader in the use of this product, and therefore Acorn Computers shall not be liable for any loss or damage whatsoever arising from the use of any information or particulars in, or any error or omission in, this guide, or any incorrect use of the product. Refer to the explicit instructions for installation supplied with upgrades.

### **WARNING: THIS COMPUTER MUST BE EARTHED**

Important: The wires in the mains lead for the computer are coloured in accordance with the following code:

Green and yellow	Earth
Blue	Neutral
Brown	Live

For United Kingdom users

The moulded plug must be used with the fuse and fuse carrier firmly in place. The fuse carrier is of the same basic colour (though not necessarily the same shade of that colour) as the coloured insert in the base of the plug. Different manufacturers' plugs and fuse carriers are not interchangeable. In the event of loss of the fuse carrier, the moulded plug **MUST NOT** be used. Either replace the moulded plug with another conventional plug wired as described below, or obtain a replacement fuse carrier from an Acorn Computers' authorised dealer. In the event of the fuse blowing it should be replaced, after clearing any faults, with a 5-amp fuse that is ASTA approved to BS1362.

For all users

If the socket outlet available is not suitable for the plug supplied, either a different lead should be obtained or the plug should be cut off and the appropriate plug fitted and wired as noted below. The moulded plug which was cut off must be disposed of as it would be a potential shock hazard if it were to be plugged in with the cut off end of the mains cord exposed.

As the colours of the wires may not correspond with the coloured markings identifying the terminals in your plug, proceed as follows:

The wire which is coloured green and yellow must be connected to the terminal in the plug which is marked by the letter E, or by the safety earth symbol, or coloured green, or green and yellow.

The wire which is coloured blue must be connected to the terminal which is marked with the letter N, or coloured black.

The wire which is coloured brown must be connected to the terminal which is marked with the letter L, or coloured red.

## GUIDELINES FOR SAFE OPERATION

The equipment described in this guide is designed and manufactured to comply with International safety standards IEC65 (BS415) and IEC380 (BS5850), and is intended for use only as a desktop microcomputer. It should not be used for other purposes. It is most important that unpacking and installation is carried out in accordance with the instructions given in this guide.

The equipment is robustly constructed but in the interests of continued safe and reliable operation, careful handling and the following guidelines should be observed.

- DO keep the machine within a room temperature of 5 to 35 degrees C (41 to 95 degrees Fahrenheit) and a relative humidity of 15% to 95% (non-condensing).
- DO avoid sudden extremes in temperature, exposure to direct sunlight, heat sources (such *as* an electric fan heater) and rain.
- DO make sure that the equipment is standing on a suitable horizontal flat surface, allowing enough space for air to circulate when the equipment is in use.
- DO ensure that wires and cables are routed sensibly so that they cannot be snagged or tripped over. Don't tug or twist any wires or cables, or use them to hang or lift any of the units.
- DO switch off and unplug the equipment and any accessories before opening any unit, to install an upgrade, for example. The main computer unit should normally be operated with the cover attached, but it can safely be switched on with the cover removed, provided that care *is* taken not to short circuit any connections or to allow any fingers or objects in the area of the fan or disc drives when these are running. Be especially careful with jewellery. Do not attempt to open any display or monitor unit, whether supplied with this equipment or not.
- DO make sure you have read and understood any installation instructions supplied with upgrade kits before attempting to fit them. If you have any doubts, contact your supplier.
- DON'T spill liquids on the machine. If liquid does spill, turn the machine off immediately and take it to your dealer for assessment.
- DON'T drop the equipment or subject it to excessive bumping and jarring. This is particularly important if you have a hard disc installed.
- DON'T poke objects through the ventilation openings in the computer casing, and don't let items such as necklaces or bracelets drop into the openings.
- DON'T exceed a maximum power consumption of 20 watts from the Podule backplane supply.
- DON'T balance any objects or stand other equipment not designed for the purpose, on top of this equipment.

# CONTENTS

GUIDELINES FOR SAFE OPERATION	iv
<b>INTRODUCTION</b>	<b>1</b>
THE WELCOME GUIDE	1
CONVENTIONS USED IN THIS GUIDE	3
<b>SETTING UP THE COMPUTER</b>	<b>5</b>
EQUIPMENT CHECKLIST	5
WHAT TO DO IN CASE OF EQUIPMENT DAMAGE	6
IDENTIFYING COMPUTER PARTS	6
CONNECTING THE COMPUTER'S PARTS	12
CONNECTING PERIPHERALS	13
<b>INTRODUCING THE DESKTOP AND WELCOME SUITE</b>	<b>15</b>
SWITCHING ON	15
THE DESKTOP	16
THE WELCOME SUITE	17
USING THE MOUSE, WINDOWS AND MENUS	18
<b>USING THE DESKTOP AND WELCOME SUITE</b>	<b>27</b>
THE DESKTOP	27
THE WELCOME SUITE	37
<b>USING THE FONT DESIGNER</b>	<b>47</b>
CREATING CHARACTERS	48
DELETING A LINE	59
ANTI - ALIAS IN G	60
<b>USING THE MUSIC EDITOR</b>	<b>63</b>
BEFORE YOU BEGIN	63
SETTING UP	65
TRANSCRIBING MUSIC	71
PLAYING MUSIC	75
SAVING AND RECALLING MUSIC	76

<b>USING PAINT</b>	<b>79</b>
BEFORE YOU BEGIN	79
DRAWING WITH PAINT	80
<b>MANAGING DISCS</b>	<b>97</b>
HOW TO FORMAT A FLOPPY DISC	97
HOW TO MAKE A BACKUP COPY OF A FLOPPY DISC	101
COPYING FROM A HARD DISC	103
USING THE FILE MANAGER	105
<b>CONFIGURING FOR PRINTERS</b>	<b>111</b>
PRINTER SETTINGS	111
CONFIGURING PRINTER SETTINGS	112
<b>TAKING CARE OF YOUR COMPUTER</b>	<b>113</b>
HOW TO CARE FOR THE ARCHIMEDES	113
HOW TO CLEAN THE COMPUTER, MONITOR AND KEYBOARD	114
HOW TO CLEAN THE MOUSE	114
HOW TO CHANGE THE INTERNAL BATTERIES	119
HOW TO CHANGE THE FAN FILTER WHEN FITTED	123
<b>TAKING CARE OF DISCS</b>	<b>125</b>
FLOPPY DISCS	125
THE PARTS OF A FLOPPY DISC	125
CARE OF FLOPPY DISCS	126
INSERTING AND REMOVING FLOPPY DISCS	128
WRITE-PROTECTING FLOPPY DISCS	129
LABELLING FLOPPY DISCS	130
CARE OF HARD DISCS	130
<b>USING THE KEYBOARD</b>	<b>133</b>
TYPEWRITER KEYS	134
COMPUTER/KEYBOARD CONTROL KEYS	135
FUNCTION KEYS	138
NUMERIC KEYPAD KEYS	139



<b>LEARNING MORE ABOUT THE ARCHIMEDES</b>	<b>141</b>
WHAT THE COMPUTER DOES	141
HARDWARE AND SOFTWARE	143
HOW DATA IS PROCESSED	144
THE OPERATING SYSTEM	148
THE ADVANCED DISC FILING SYSTEM	149
<b>HARD DISC FORMATTING</b>	<b>151</b>
<b>INDEX</b>	<b>155</b>



# INTRODUCTION

This guide introduces you to the Archimedes 300 and 400 Series microcomputers. It is written for first-time computer users.

If you have used a computer before, we suggest you review this guide for information on how to connect the computer's parts, how to change the battery, and how to care for the computer.

The **User Guide** which accompanies this manual contains more detailed information on the computer. A **Programmer's Reference Manual** is also available separately. This is for more experienced programmers who want to make fuller use of the power available in the Archimedes.

If this is your first experience with a computer, read each chapter in this guide carefully. A little time spent learning about the Archimedes and computers in general will save you time later.

## THE WELCOME GUIDE

**SETTING UP THE COMPUTER** explains in detail how to set up and begin operating your computer. It includes a discussion of computer parts. We recommend you read through this chapter, whatever your level of experience, as it contains information specific to the Archimedes Series microcomputers.

**INTRODUCING THE DESKTOP AND WELCOME SUITE** talks about the desktop and Welcome Suite. It discusses the icons, menus and windows which are part of the desktop (a feature of the Archimedes), and includes instructions on how to use the mouse.

**USING THE DESKTOP AND WELCOME SUITE** tells you how to access and use the desktop and Welcome Suite programs, on your floppy or hard disc.

**USING THE FONT DESIGNER** tells you how to design your own characters using the Font Designer program in the Welcome Suite.

**USING THE MUSIC EDITOR** tells you how to transcribe sheet music onto your computer, as well as how to play back what you have transcribed.

USING PAINT tells you how to use the excellent graphics and colour capabilities of the Archimedes to draw, paint and produce your own designs.

MANAGING DISCS tells you how to perform simple disc management tasks such as formatting on floppy disc, backing up discs, and copying and deleting files on your disc.

CONFIGURING FOR PRINTERS tells you how to inform the computer about what type of printer you are using.

TAKING CARE OF YOUR COMPUTER tells you how to care for the machine, including how to clean the mouse, how to change the batteries and how to change the fan filter (if fitted).

TAKING CARE OF DISCS covers the care and handling of discs.

USING THE KEYBOARD discusses the differences between the computer keyboard and a typewriter keyboard, and explains how to use the Archimedes keyboard.

LEARNING MORE ABOUT THE ARCHIMEDES provides information on computers in general and the Archimedes in particular. It is intended to help you understand how computers work in general, and how best to exploit your own machine.

HARD DISC FORMATTING tells you how to format a hard disc.

## CONVENTIONS USED IN THIS GUIDE

The following conventions are used throughout this guide:

- Keytops and the symbols used to represent events or objects (called icons in computer terminology) are shown as you see them on the keyboard and screen. For example, press [Shift] means you must hold down the key marked [Shift]
- Computer parts are referred to by the names used on the computer. For example, RS423 refers to the serial port on the back of the computer.
- Text that you enter and text that appears on the screen is shown as follows:  
  
This is text that appears on the screen.
- Combinations of keys are referred to by key name. For example, [Ctrl][Break] means you must hold down the [Ctrl] key and press and release the [Break] key.
- The buttons on the mouse are referred to by name as follows: select, menu, adjust.
- Text that is part of a Welcome Suite program, such as the title of a specific screen or menu, appears in italics as follows:

*Pen menu*



# SETTING UP THE COMPUTER

This chapter describes the computer's parts and explains how to connect them in preparation for operation.

## EQUIPMENT CHECKLIST

The following is a list of equipment which is included with the computer. If any of the items is missing or damaged, notify your supplier immediately.

- Computer unit
- Mains lead
- Mouse with connector
- Keyboard with connector
- Welcome Guide
- User Guide
- Welcome Disc (not supplied with the Archimedes 440)
- Registration form
- Guarantee card
- Keystrip card
- User response form

If you have purchased a monitor as well as the computer, a list of equipment which comes with the monitor is provided by the manufacturer, along with instructions on how to connect it to a computer.

The registration form should be filled in and returned to the address indicated on the form. Returning the registration form means that you will be kept informed of Archimedes developments.

Keep the boxes and polystyrene inserts so that you can safely transport the machine should you need to do so in the future.

The user response form is for you to use to send Acorn any comments or suggestions you have regarding the Archimedes. Fill it in after you have used the computer for a time and return it to the address indicated on the form.

## WHAT TO DO IN CASE OF EQUIPMENT DAMAGE

Should you discover any faults in the equipment as a result either of damage caused during shipping or of defects in manufacturing, notify your supplier straight away.

## IDENTIFYING COMPUTER PARTS

This section introduces you to the various computer parts. It is important to be familiar with them before you begin operating the machine.

Front view

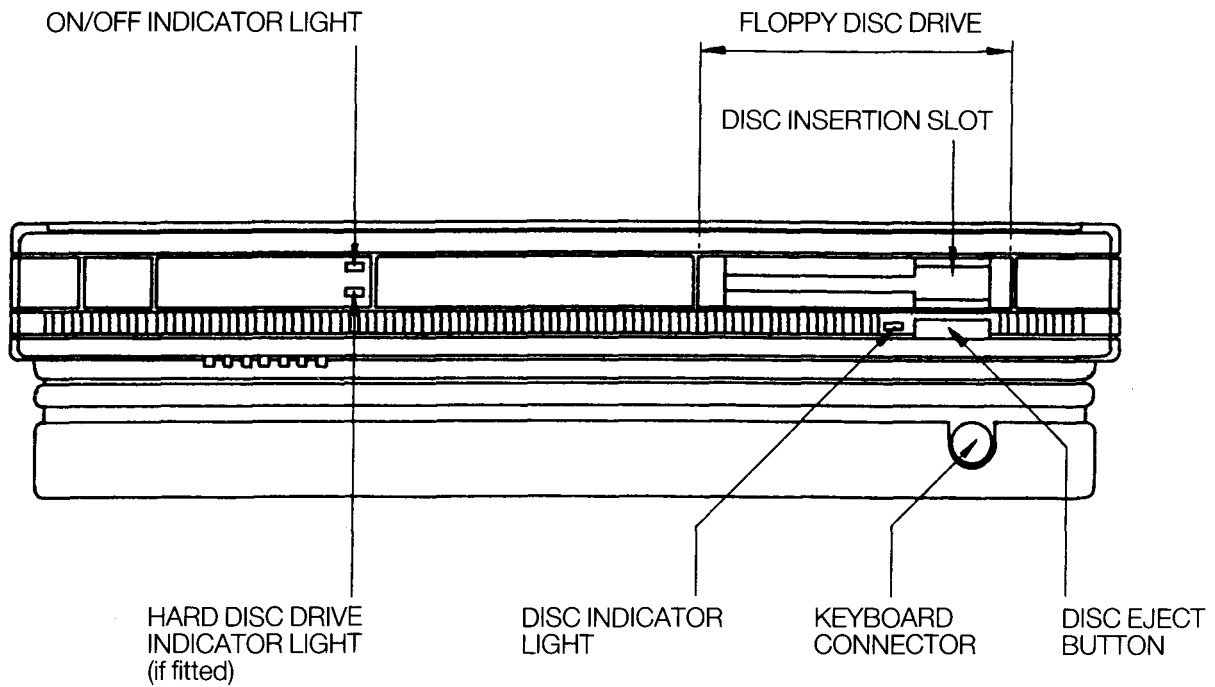



The drawing above shows the front of the computer. The items below are discussed from left to right as you face the front of the unit.

*On/off indicator light:* This light comes on when the computer is turned on.

*Hard disc drive indicator light if fitted:* the drive's indicator light comes on when the hard disc drive is being accessed by the system.

— *Note:* the Archimedes 440 has a hard disc drive fitted as standard. A hard disc can be fitted as an optional upgrade to other Archimedes 300/400 series products. See your supplier for information on fitting a hard disc.

*3½ inch floppy disc drive:* The floppy disc drive is located on the right. It includes a disc insertion slot, drive indicator light, and disc eject button.

*Disc insertion slot:* The disc insertion slot is a narrow, horizontal opening in the middle of the drive into which a 3½ inch floppy disc is inserted. The disc enters the machine at a downward slant.

*Floppy disc indicator light:* The drive's disc indicator light comes on when the floppy disc drive is being accessed by the system.

— **CAUTION:** When either the hard or floppy disc drive indicator light is on, the computer is actually reading or writing data. Do not remove a floppy disc, move or turn off the computer while the light is on.

*Disc eject button:* The disc eject button releases the floppy disc so that it can be removed from the drive. When you press the button, the disc pops partially out of the slot, allowing you to remove it by hand.

*Keyboard connector:* The keyboard connector is located just below the floppy disc drive. It receives the coiled cable connected to the keyboard.

Rear view

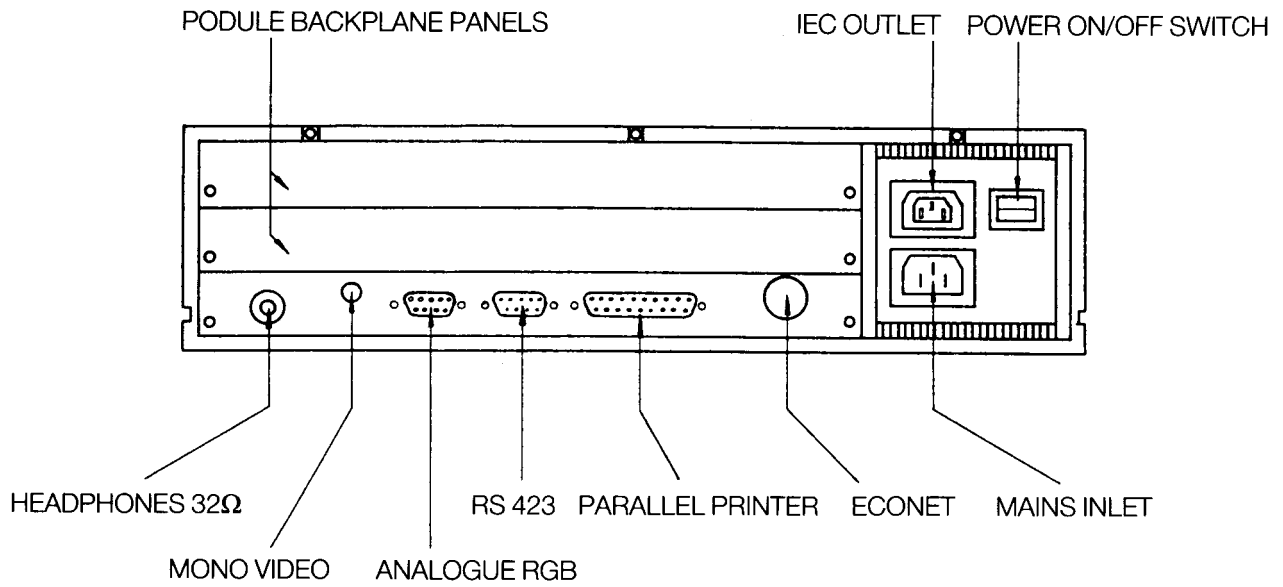

The drawing above shows the back of the computer. The items below are discussed from left to right as you face the back of the unit.

*Podule Backplane* panels: the blank panels provide access to a two socket backplane capable of holding up to two single width or two double width Podules (Peripheral Modules). Podules are expansion cards which allow you to enhance the system capabilities. See your supplier for a list of Podules available for your Archimedes and information on installation.

If you have an Econet module installed in the machine (see 'Econet' later in this chapter), then only a single width Podule can be fitted in the lower of the two sockets.

— *Note:* on the Archimedes 400 series a four socket backplane is fitted as standard capable of holding up to four single width or two double width Podules. If you have an Econet module installed in the machine, then only a single width Podule can be fitted in the lower position.

*Headphones 32 ohm:* The headphones 32 ohm socket allows you to connect stereo headphones or your stereo amplifier system to the computer through which you can hear sound produced by the computer. The lead must have a 3.5mm stereo jack plug.

*Mono video:* On the Archimedes 300 series, a phono socket is provided to connect a standard resolution monochrome monitor to the machine.

The Archimedes 400 series has two BNC connectors (labelled SYNC and MONO, 75ohm HI-RES MONITOR O/P) instead of the phono socket on the Archimedes 300 series, to allow connection of a high resolution monochrome monitor. The Archimedes 400 series has additional screen modes available which are capable of providing high resolution displays. These additional modes can only be used on high resolution monochrome monitors. (See the User Guide chapter, **SCREEN MODES** for information.) It is possible to have your Archimedes 400 series computer adjusted internally to allow connection of a standard resolution monochrome monitor. See your supplier for details of this adjustment.

See your supplier for information on the kinds of monochrome monitors that will work with your Archimedes.

*Analogue RGB:* This socket is used to connect an RGB (colour) monitor to the computer (it is not suitable for TTL RGB monitors). See your supplier for information on the kinds of colour monitors that work with the Archimedes.

*RS423:* This is the serial socket. You can use it to attach a serial device such as a modem.

*Parallel printer:* This socket is used to connect the computer to a parallel printer (parallel printers are discussed in the section, Connecting the computer's parts).

*Econet:* This socket connects the computer with other Acorn computers on a local area network. A local area network allows you to communicate with several computers within a single geographic location. To use the Econet, you must install an optional Econet module in the machine. A blanking plug may be fitted to this socket if the Econet upgrade is not installed. See your supplier for more information on Econet.

*Power on/off switch:* The power on/off is a rocker switch. The 0 symbol indicates OFF and the I symbol indicates ON.

- **CAUTION:** never switch the computer off while either the hard or floppy disc indicator light is on. Always remove the floppy disc from the drive before you switch the computer off.

If you have a hard disc installed in the Archimedes, it is important that you park the drive heads before you switch the computer off. This will prevent any damage to the disc during transport or if the computer is accidentally jolted. To park the drive heads, click menu on the hard *disc* icon in the desktop and a window containing the word *bye* will appear. Click select on the word *bye* and the hard disc heads will be parked. Information on using the mouse and icons is given in the chapters, **INTRODUCING THE DESKTOP AND WELCOME SUITE** and **USING THE DESKTOP AND WELCOME SUITE**.

*IEC 320 outlet:* The mains cable of some monitors can be attached to this outlet. See the instructions accompanying your monitor for information.

*Mains inlet:* The three-pin mains plug, located on the power supply area, connects the computer's power lead to a standard mains wall outlet.

## Keyboard

The keyboard contains 103 keys. The function of each one is described in the chapter, USING THE KEYBOARD.

### Rear view

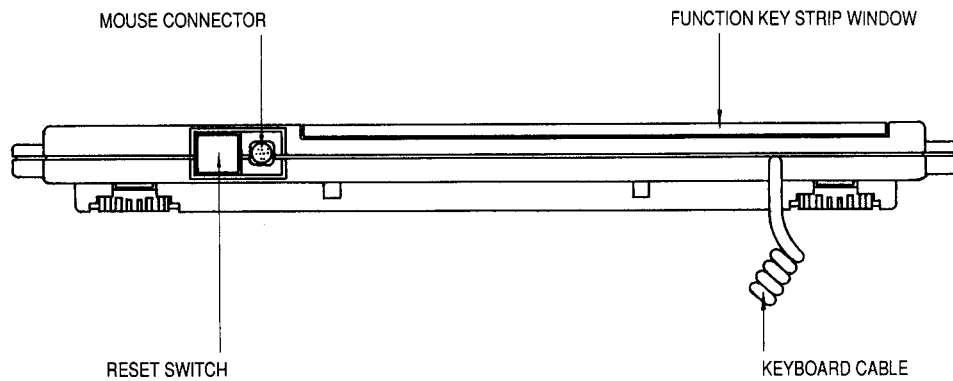

The drawing above shows the back of the keyboard. References to 'left' and 'right' in the discussion below assume you are facing the back of the unit.

The reset switch is used to restore the computer to its initial 'switch on' state without actually turning it off at the on/off switch.

The 9-way connector on the far left is used to attach the mouse cable to the keyboard. The other end of the cable is permanently fixed to the mouse.

The coiled cable to the right of the mouse connector is permanently attached to the keyboard. It connects the keyboard to the computer.

The function key strip window provides a holder for function key cards. A function key card provided with an application software package will identify the use of each

function key (labelled [F1] to [F12] ) within that application. The window is hinged so that you can angle it for easy viewing.

### **Monitor**

Refer to the documentation accompanying the monitor for information on this part of the system.

## **CONNECTING THE COMPUTER'S PARTS**

Connect the keyboard, mouse, monitor and mains lead in preparation for operation as follows:

- 1 Place the computer unit on a flat, smooth horizontal surface near a mains power outlet with the keyboard directly in front of it. Avoid soft surfaces, such as carpets, which may block ventilation. Allow space at the rear for easy access to the cables.
- 2 Plug the coiled cable attached to the keyboard into the keyboard connector socket on the front of the computer.
- 3 Plug the cable attached to the mouse into the 9-way connector on the keyboard.
- 4 Place the monitor on top of the computer unit.

If you are connecting a standard resolution monochrome monitor, insert the signal cable connected to the monitor into the phono socket labelled 'MONO VIDEO' on the back of the computer.

If you are connecting a high resolution monochrome monitor to your Archimedes 400 series computer, insert the signal cables connected to the monitor into the two BNC connectors labelled 'SYNC' and 'MONO' on the back of the computer.

If you are connecting a colour monitor, insert the signal cable connecting the monitor to the computer unit into the socket labelled 'ANALOGUE RGB' on the back of the computer. The other end plugs into the monitor.

If you are uncertain as to how to connect the monitor, see the instructions supplied with the monitor, or refer to your supplier for assistance.

- 5 Consult the instructions accompanying the monitor for information on how to connect it to a mains outlet. (It may be suitable for plugging into the IEC 320 outlet on the rear of the computer near the on/off switch.)
- 6 Set the brightness and contrast controls on the monitor unit to approximately their mid-positions. See the instructions accompanying the monitor if necessary.
- 7 Attach the mains power lead to the mains plug on the back of the computer. Insert the other end into the mains wall outlet.

You are now ready to switch the computer on. However, if you want to attach any other peripheral devices (such as a printer) you should always switch off first at the mains.

## CONNECTING PERIPHERALS

This section describes how to connect a parallel printer, serial device and headphones to the computer.

### **Connecting a parallel printer**

The computer can be connected to most standard (Centronics-compatible) parallel printers.

The connectors on the ends of the cable connecting the printer to the computer are different from one another, and generally cannot be inserted incorrectly. One end is plugged into the 25 way D-type socket labelled 'PARALLEL PRINTER' on the back of the computer. The other end is attached to the printer.

If you are uncertain how to connect the cable to the printer, or whether the printer you are using is parallel or serial, see the instructions accompanying the printer.

— *Note:* the term `parallel' means that information is transmitted to the printer one character or 'byte' (eight bits) at a time. Bits and bytes are discussed in greater detail in the chapter, **LEARNING MORE ABOUT THE ARCHIMEDES.**

If you wish to know more about parallel connectors and pin assignments, see the chapter, **PRINTERS** in the **User Guide.**

### **Connecting a serial device**

The socket labelled RS423 allows you to connect a serial device, such as a modem, to the computer.

### **Connecting headphones**

You can connect headphones to the computer using the socket labelled 'Headphones 32 Ohm'. You need to use 32 ohm headphones with a 3.5mm stereo jack plug ('personal stereo' headphones are suitable). Consult your supplier if you require further information.



# INTRODUCING THE DESKTOP AND WELCOME SUITE

Once the computer's parts are connected you are ready to begin using the system. This chapter tells you what happens when you switch on and includes instructions on how to use the mouse, windows and menus. We suggest you read through it even if you are familiar with a 'desktop' facility as it will assist you in using the Welcome Suite and desktop on the Archimedes.

## SWITCHING ON

Turn the computer on and adjust the brightness and contrast controls on the monitor if necessary. After a few seconds, the screen should display the following:

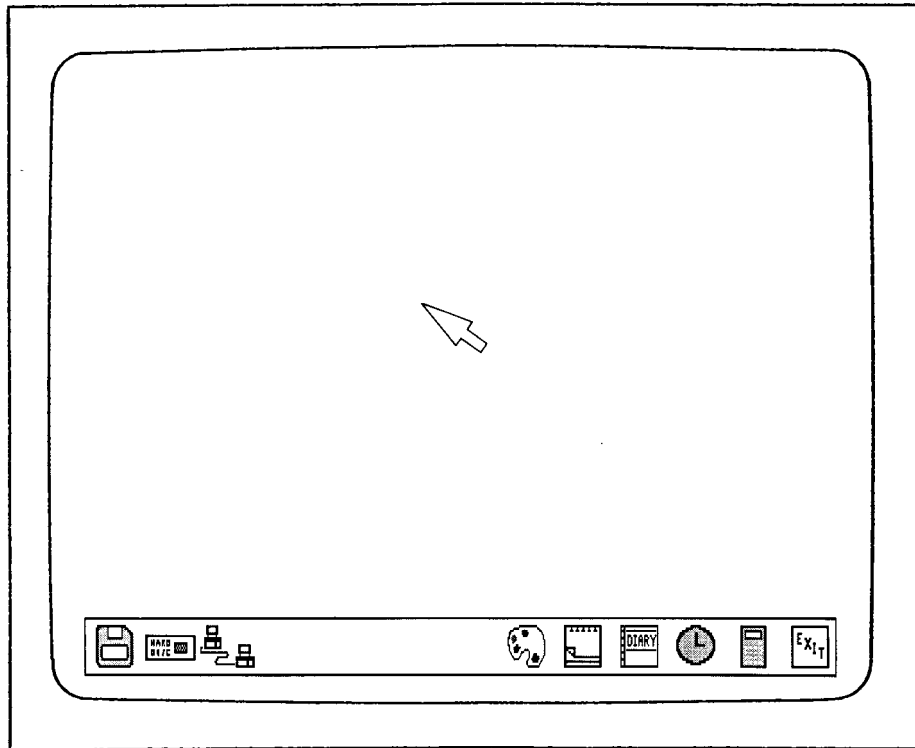

This is the main *desktop* screen. The pictures along the bottom of the screen are called icons. Whenever you switch on the computer, this screen appears by default. You can change (configure) the computer if you wish so that when you switch on, the BBC BASIC prompt or an operating system prompt appears instead of the desktop. See the User Guide for information.

— *Note:* the hard *disc* and/or network icon will not be displayed unless your Archimedes is fitted with a hard disc and/or Econet.

If you have a hard disc installed in the Archimedes, it is important that you park the drive heads before you switch the computer off. This will prevent any damage to the disc during transport or if the computer is accidentally jolted. To park the drive heads, click menu on the hard *disc* icon in the desktop and a window containing the word *bye* will appear. Click *select* on the word *bye* and the hard disc heads will be parked. Information on using the mouse and icons is given later in this chapter and in the chapter **USING THE DESKTOP AND WELCOME SUITE**.

## THE DESKTOP

The desktop facility lets you treat the computer as you would a desk. The computer screen represents the top of the desk. Items which might normally appear on a desk, such as a diary and Note-Pad, are provided. These items are always 'available' when you turn the computer on.

Icons are symbols used to represent objects making them easier to recognise than a wordy explanation. The icons on the main *desktop* screen represent items available for you to display, observe and work with.

Using the icons is discussed in the chapter, **USING THE DESKTOP AND WELCOME SUITE**.

## THE WELCOME SUITE

The Welcome Suite contains programs which introduce you to the Archimedes. These programs are described in the chapter, **USING THE DESKTOP AND WELCOME SUITE**.

If you have an Archimedes 440, the Welcome Suite will be provided on the hard disc and your computer will be configured to use the hard disc and not the floppy disc, by default. Throughout this chapter and the Welcome Guide, it is therefore assumed that all references relating to disc refer to both hard and floppy disc unless otherwise stated.

– *Note:* it is strongly recommended that you backup the Welcome Disc before you follow any of the examples in this guide. This topic is described in the chapter, **MANAGING DISCS**.

On the Archimedes 440 system, the Welcome Suite and a hard disc format program called WFORM (in the Library directory) are supplied on the hard disc. It is strongly recommended that you make a backup copy of the Welcome Suite and WFORM onto a floppy disc. Should your hard disc become corrupted in some way you can then reinstall the Welcome Suite. (See the chapter, **MANAGING DISCS** for information on copying files using the File menu.)

If you wish to keep the Welcome Suite on the hard disc but not in the \$ directory, you could transfer the Welcome Suite to a sub-directory, for example \$ . Welcome. In this case, to run the Welcome Suite, you must reset your user root directory to be \$ . welcome. (See the **User Guide** for information on the \*URD command.)

## USING THE MOUSE, WINDOWS AND MENUS

Familiarity with the mouse, windowing system, and menus is essential to using the desktop and Welcome Suite.

### The mouse

The mouse is used to move a special icon called a pointer. The pointer is a small arrow that appears on nearly every desktop and Welcome Suite screen. Learning to use the mouse takes very little time. You can become familiar with how it operates while becoming familiar with the desktop programs as well as with the programs in the Welcome Suite.

The mouse should be set on a hard, unpolished surface. On a soft surface the roller ball on the underside of the mouse does not make the contact it needs to move the pointer on the screen.

The mouse should be held with the cable pointing away from you.

The mouse is used to move the pointer to various parts of the screen. Moving the mouse to the left or right moves the pointer to the left- or right-hand side of the screen. Moving the mouse forwards and backwards moves the pointer to the top and bottom of the screen.

The pointer does not move when the mouse is lifted off the hard surface. You can, therefore, pick the mouse up and set it down again if you run out of room while manipulating the pointer with it.

The mouse has three buttons. From left to right they are: select, menu and adjust. The functions they perform depend on the application you are using.

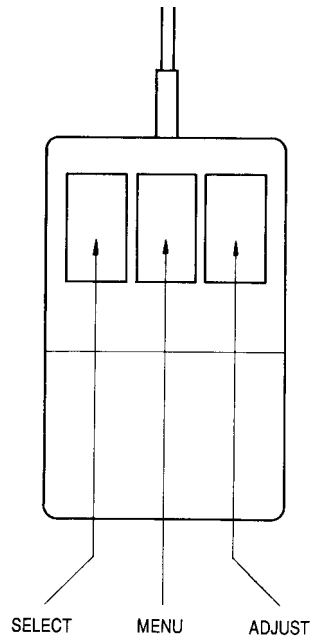

Pressing and releasing a mouse button is known as 'clicking'. For example, 'click **select**' means 'press and release the **select** button'. Rapidly pressing and releasing a mouse button twice *is* known as 'double-clicking'.

### Using the mouse

To practise with the mouse, follow the steps below. The example chosen for this explanation is the Calculator function in the desktop:

- 1 Move the pointer to the *calculator* icon which appears at the bottom of the desktop screen.
- 2 Click **select**. The calculator appears on the screen.

- 3 Position the pointer on a number and click **select**. The number appears in the calculator display area.
- 4 Position the pointer on one of the calculation symbols (for example '+' ) and click **select**.
- 5 Position the pointer on another number and click **select**. The number appears in the calculator display area.
- 6 Move the pointer to the '=' sign and click **select**. The result of the calculation appears in the calculator display area.
- 7 Move the pointer to the 'X' icon on top of the calculator. Click **select**. The calculator vanishes from the screen.

As you continue using the Archimedes and become familiar with the desktop facilities, you will find yourself operating the mouse without effort.

### **Windows**

A window is an area of the screen which displays information independently of another area of the screen. The following is a simple introduction to the windowing system.

The drawing opposite is of a complete window with all the separate areas labelled according to their function.

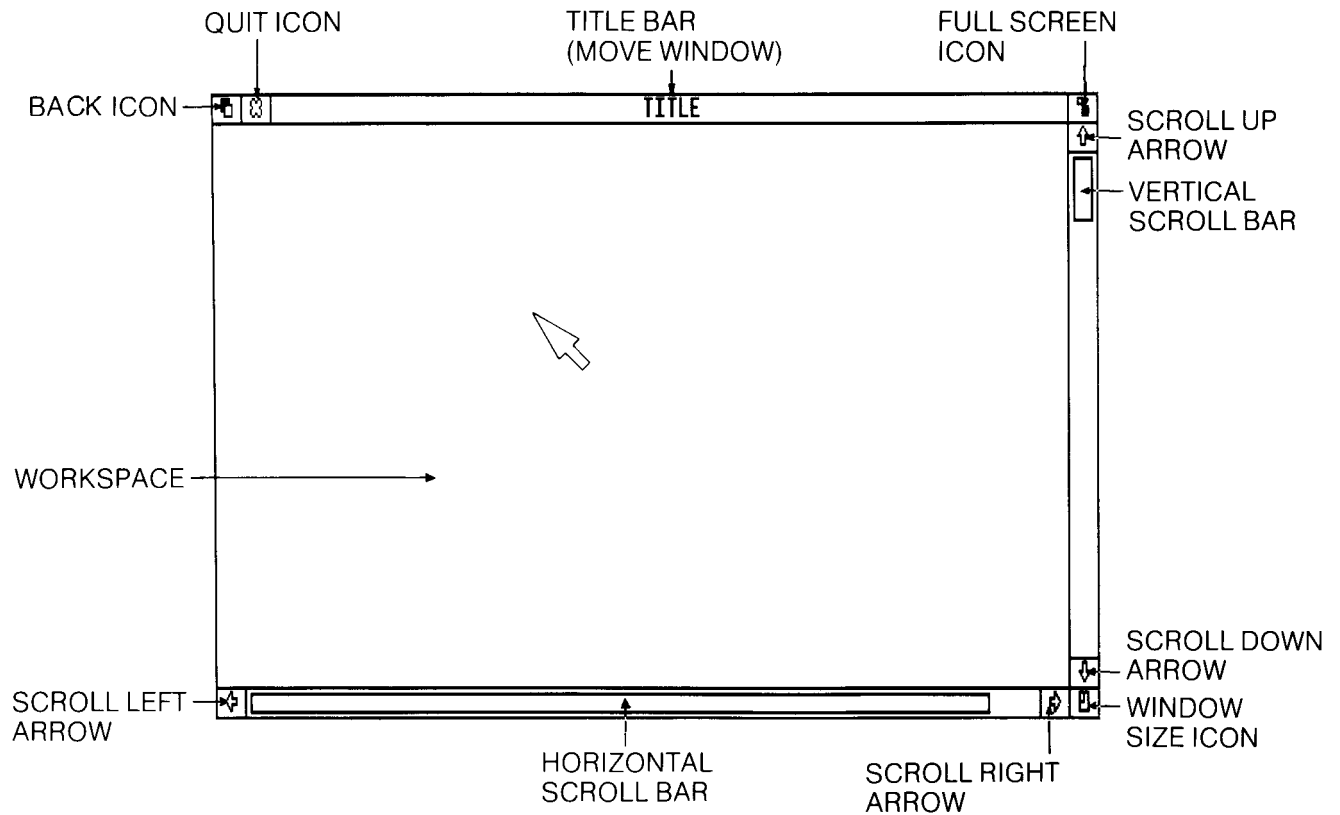

Windows are one of the main ways of displaying and manipulating information.

Areas within a window are selected using the mouse and pointer.

Some windows include a title bar at the top. The large area in the centre of the window is called the workspace. Some windows contain bars along the side and bottom enabling you to move or 'scroll' the information in the workspace so that you can view a different part of the information.

You can have many windows open or active on the screen at the same time.

You can work on any window open on the screen regardless of its position or the number of other windows also displayed on the screen.

You can open and close windows, move them around the screen, and change their size.

### **Using windows**

To practise using the windowing system, follow the instructions below; they take you through each aspect of the window as shown in the drawing above. The example chosen is the *Note-Pad* function in the desktop.

*Move window:* This function allows you to move a window to any part of the screen.

- 1 Move the pointer to the *Note-Pad* icon and click **select**. The Note-Pad window appears on the screen.
- 2 Position the pointer anywhere on the title bar at the top of the window. Be careful not to position the pointer on one of the icons on either side of the title bar.
- 3 Press and hold **select**. The window *is* outlined by a moving dotted line.
- 4 Keeping **select** pressed, move the pointer to another part of the screen. Do not lift your finger from the button. This method of moving the pointer with your finger on a button is also known as 'dragging'. The dotted outline moves with the pointer.
- 5 Release **select** when you reach the part of the screen where you wish the *Note-Pad* window to rest. The dotted outline disappears and the *Note-Pad* window takes its place on the newly selected part of the screen.



*Full screen:* This function allows you to enlarge the window to its maximum size.

- 1 Make sure the *Note-Pad* window is displayed on the screen.
- 2 Move the pointer to the *full screen* icon and click **select**. The *Note-Pad* window fills the entire screen.
- 3 Re-position the pointer on the *full screen* icon and click **select**. The *Note-Pad* window returns to its original size.

*Vertical and horizontal scroll:* This function allows you to see data which does not appear in the window, as the area of a window is often too small to display all the data the window contains.

Vertical scrolling means that lines enter at the top of the window and disappear at the bottom, or enter at the bottom of the window and disappear at the top.

Horizontal scrolling means that characters enter at the right of the window and disappear to the left, or enter at the left of the window and disappear to the right.

- 1 Make sure the *Note-Pad* window is displayed on the screen.
  - 2 Move the pointer into the *Note-Pad* workspace and click **select**. The title bar changes colour after you click and a vertical bar, called a caret, appears in the *Note-Pad* workspace. The caret indicates where in the workspace the next character typed will appear. It is possible to reposition the caret by moving the pointer and clicking **select** or by using the four arrow (or cursor) keys on the keyboard.
- *Note:* the caret is always between characters and the characters typed always appear to the left of the caret.

- 3 Enter at least ten lines of text from the keyboard (see the KeyTutor tutorial for information on how to use the keyboard). It does not matter if the text disappears beyond the right side of the window. Press [Return] at the end of each line. Putting text on the screen in this way gives you a chance to see how scrolling works.
- 4 Position the pointer on the *vertical scroll* bar. Press and hold **select**. The scroll bar is outlined by a moving dotted line.
- 5 Keeping **select** pressed, move (drag) the pointer in the direction of the *scroll down* arrow. The dotted outline moves with the pointer.
- 6 Release **select**. The last line of text should appear in the window. If it does not, you may have scrolled too far. Keeping the pointer on the *vertical scroll* bar, click **select** again. Move the dotted outline in the direction of the *scroll up* arrow, releasing it before you get to the top of the bar. The last line of text should be in the window. If it is not, practise moving the scroll bar until the text appears.
- 7 Try scrolling horizontally, dragging the scroll bar to the left and right to display any hidden text on the screen.

Change *window size*: This function allows you to change the size of the window by dragging the lower right-hand corner.

- 1 Make sure the *Note-Pad* window is displayed on the screen.
- 2 Position the pointer on the *change window size icon*. Press and hold **select**. The window is outlined by a moving dotted line.
- 3 Keeping **select** pressed, move the pointer to another part of the screen. The dotted outline changes size and shape depending on where you position the pointer on the screen.
- 4 Release **select**. The window takes the position, size and shape previously occupied by the dotted outline.

*Quit:* This function removes the window from the screen.

- 1 Make sure the *Note-Pad* window is displayed on the screen.
- 2 Position the pointer on the quit icon and click **select**. The *Note-Pad* window disappears from the screen.

*Back icon:* This allows you to move windows behind each other if you are working with more than one window on the screen at the same time. Putting a window behind another window does not alter the information displayed in the window.

- 1 Begin with the *main desktop* screen free of windows.
- 2 Position the pointer on the *Note-Pad* icon and click **select**. The *Note-Pad* window appears on the screen.
- 3 Position the pointer on the *Palette* icon and click **select**. The *Palette* window appears on the screen overlaid on top of the *Note-Pad* window.
- 4 Position the pointer on the *back* icon of the *Palette* window and click **select**. The *Palette* window will partially disappear behind the *Note-Pad* window.
- 5 Position the pointer on the back icon of the *Note-Pad* window and click **select**. Now, you have reversed the process and the Note-Pad will 'disappear' behind the palette.

## **Menus**

A menu is a list of options you can choose from in order to carry out different functions.

Menus appear by clicking the **menu** button.

Choose an option from the menu by positioning the pointer on one of the options and clicking **select**.

See the section, **The Note-Pad icon** in the chapter **USING THE DESKTOP AND WELCOME SUITE** for an example of the use of the **menu** button.



# USING THE DESKTOP AND WELCOME SUITE

This chapter tells you how to access and use the desktop and the Welcome Suite programs.

## THE DESKTOP

When you turn the computer on, the first screen displayed is the main desktop screen.

This section tells you about the icons displayed in the bar along the bottom of the screen.



You can choose to use several of the items represented by the icons at one time, just as you can have a clock, calendar and calculator on the top of a desk all at the same time. It is because this computer facility is so much like working at a desk that it is referred to as a desktop.

To select these icons, position the pointer on the icon you require and click select.

If the window that appears displays only part of its contents due to its small size, enlarge it for ease of use. Position the pointer on the full *screen* icon on the top right-hand corner of the window and click select. The window appears at full screen size.

### The floppy disc icon

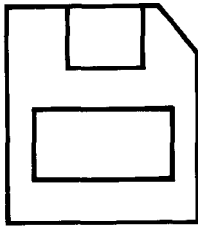

Selecting this icon displays a catalogue of files and directories on the floppy disc.

### The hard disc icon



This icon appears next to the floppy disc icon only if you have a hard disc drive attached to your computer. Clicking select on this icon displays a catalogue of files and directories on the hard disc.

— **CAUTION:** if you have a hard disc installed in the Archimedes, it is important that you park the drive heads before you switch the computer off. This will prevent any damage to the disc during transport or if the computer is accidentally jolted. To park the drive heads, click **menu** on the *hard disc* icon in the desktop and a window containing the word **bye** will appear. Click **select** on the word **bye** and the hard disc heads will be parked.

### The Note-Pad icon

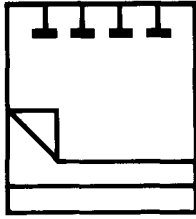

This icon represents a Note-Pad. You can use the Note-Pad to write notes, keeping them separate from other items you are working on.

Select the Note-Pad by positioning the pointer on the *Note-Pad* icon and clicking **select**.

To write a note, position the pointer anywhere in the *Note-Pad* window and click **adjust** to activate the workspace. Then type your note.

If you wish you can save the contents of the Note-Pad onto a disc. To do this:

- 1 Position the pointer anywhere in the *Note-Pad* window.
- 2 Click **menu** to display the *Note-Pad* menu.
- 3 Position the pointer on the *Save* option and click **select**. A window appears containing the name of the file in which your note will be saved.
- 4 If you position the pointer on **OK** and click **select**, the contents of the Note-Pad will be saved in a file called NotePad.

It is possible to use the Note-Pad to save more than one note by giving each note a new filename before you save it. To save a new note:

- 1 Write your note and select *Save* as described above.
- 2 Delete the existing filename in the *Save* window by repeatedly pressing the 'COY' key (this deletes the character to the right of the caret, the 'Delete' key deletes the character to the left of the caret).
- 3 Enter your own new file name from the keyboard.
- 4 Click **select** on OK and your note will be saved with the new file name you have chosen.

If you do not change the name of the file each time you save a new note, then your original note will be overwritten and lost.

If you are using an Archimedes 300 series machine with floppy disc, you will find that as there are already a large number of files saved onto your Welcome Disc, there is not much room to save your own Note-Pad entries. If you wish to save lots of files of your own then it is best to replace the Welcome Disc with a blank, formatted disc (for information on formatting a floppy disc see the chapter, MANAGING DISCS).

To do this you must first remove the floppy disc catalogue window from the screen by clicking **select** on the *quit icon*. You can now replace your Welcome Disc with a blank, formatted floppy disc and click **select** on the *floppy disc icon*. You will see a catalogue of your new disc which is now available for you to save your Note-Pad entries to.

Remember that you should always *quit* the current floppy disc catalogue window before changing a disc in the desktop and click **select** on the *floppy disc icon* once you have inserted your new disc.



To load and display a previously saved note in the Note-Pad, take the following steps:

- 1 Select Note-Pad by positioning the pointer on the *Note-Pad* icon and clicking select (if it is not already selected).
- 2 Click select on the *disc* icon to display a catalogue of the files on the disc which contains the note to be loaded. It may now be necessary to adjust the positioning and size of the two windows on the screen to allow viewing of both windows simultaneously.
- 3 Position the pointer on the file you wish to be loaded into Note-Pad, eg Notepad, and click select. You will know which file is selected because the name bar changes colour.
- 4 Position the pointer in the *Note-Pad* workspace and click menu.
- 5 Click **select** on the *load* option and the note which was saved in the selected file will be loaded and displayed in Note-Pad
- 6 It is also possible to load a previously saved note by positioning the pointer on the selected file in the disc catalogue and double-clicking on the select button. This will have the same effect as steps 3 to 5 above.

## The diary icon



This icon represents a diary. You can use this diary as you would any diary to keep track of appointments, meetings and other daily information you might need.

Select the Diary by positioning the pointer on the *Diary* icon and clicking **select**.

To find the month in which you want to make an entry, position the pointer on the left or right scroll arrow near the top of the window and click **select**. Scroll backwards or forwards through the twelve months of the year until you reach the one you require.

To choose a day on which to make an entry, position the pointer on the date of the month you require and click **select**. A *Diary* window for that date is displayed.

You can now type in your Diary entry for the date selected. If you wish you can select other dates and make several more entries in your Diary.

To save your Diary entries, take the following steps:

- 1 Position the pointer anywhere on the Diary window.
- 2 Click **menu** to display the *Diary* menu.
- 3 Position the pointer on the *Save* option and click **select**. A window appears containing the name of the file in which your diary entries will be saved.

- 4 Position the pointer on OK and click **select**. Your Diary entries will be saved on the Welcome Disc or hard disc in a file called `diary 1987`.

You may wish to keep more than one Diary, one for home and one for business, in which case you must save each Diary with a different name. To save a new Diary under a different name, take the following steps:

- 1 Make your Diary entries and select *Save* as described above.
- 2 Delete the existing file name in the *Save* window by repeatedly pressing the [Copy] key.
- 3 Enter your new file name.
- 4 Click **select** on OK and your new Diary will be saved with the new file name you have chosen

To load and display a previously saved Diary take the following steps:

- 1 Click **select** on the *disc* icon to display a catalogue of the files on the disc containing the Diary you wish to load.
- 2 Position the pointer on the Diary file you wish to load, eg `diary1987`, and double-click **select**.
- 3 Your Diary will now be loaded and you will be able to read through your diary entries by selecting the appropriate dates.

## The palette icon

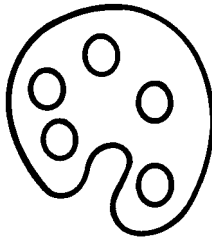

This icon represents a palette of colours. You can use the facility it provides to produce any of the 4096 colours available on the Archimedes. It allows you to choose the colours you want displayed on the screen. For example, you can choose the background and foreground screen colours as well as the colours of windows.

Select the palette by positioning the pointer on the *Palette* icon and clicking select. A *Palette* window will appear.

In order to change colours which appear on the Desktop screen, you can adjust the amount of red, green and blue which make up any of the 16 colours displayed in the *Palette* window. For example to change the colour of the white areas of the screen, take the following steps:

- 1 Position the pointer on the white square of the *Palette* window and click **select**. The white square will now be surrounded by a darker outline.
- 2 Position the pointer on the slider labelled B (blue) at the top of the *Palette* window and click **select**. Keeping **select** pressed, drag the blue slider up and down and you will see that the previously white areas of the screen become more or *less* yellow in colour depending on the slider position, ie the amount of blue in these areas.
- 3 Adjusting the R (red) and G (green) sliders will also effect the colour of the previously white areas of the screen.

If you wish to change another screen colour then select the colour to be changed from the palette and adjust the red, green and blue elements by moving the sliders as described above.

The box labelled *Bor* in the *Palette* window allows you to change the colour of the border area around the desktop screen. To change the border colour click **select** on the *Bor* box and then adjust the red, green and blue sliders.

The boxes labelled *Ms1* and *Ms2* allow you to change the colour of the border and the interior of the pointer respectively. *Ms3* is not currently used.

To save a particular palette, take the following steps:

- 1 Click **select** on save in the *Palette* window and a *Save* window will appear.
- 2 Click **select** on OK in the *Save* window and your palette will be saved as the file !Palette.

If you wish to save more than one palette then make sure that you select a new file name each time you save a new palette (see the section, **The Note-Pad icon** for details on how to save more than one file).

In order to load and display your previously saved palettes, take the following steps:

- 1 Click **select** on the *disc* icon to display a catalogue of files on the disc containing the palette you wish to load.
- 2 Position the pointer on the palette file that you wish to load, eg !Palette, and double-click **select**.

Your new palette will now be loaded and displayed.

If you wish to return your screen to its original colours press [Ctrl] [Break] and the default palette contained in the ROM will be used when desktop is restarted.

### The clock icon

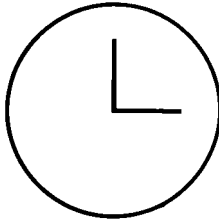

This icon represents a clock. The clock contains both analogue and digital timepieces.

Select the clock by positioning the pointer on the clock icon and clicking **select**.

To set the time, position the pointer anywhere on the *Clock* window. Click **menu**. A window will appear which allows you to change the hours, minutes and seconds by clicking **select** on the '+' and '-' boxes. When you have set the time correctly, click **select** on OK.

### The calculator icon

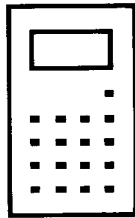

This icon represents a calculator. Use the calculator as you would any standard calculator to add, subtract, multiply and divide.

For further information on using the calculator, see the section, **Using the mouse** in the chapter **INTRODUCING THE DESKTOP AND WELCOME SUITE**.

**The exit icon**

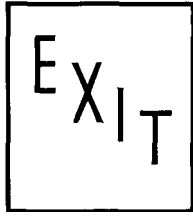

This icon quits the desktop. Select it when you need to perform a function outside the desktop. It will return you to the operating system prompt.

**The network icon**

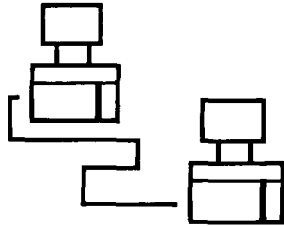

This icon appears only if you connect the Archimedes to a network. It allows you to access information on the network.

**THE WELCOME SUITE**

The Welcome Suite contains programs that introduce you to the Archimedes. To load the Welcome Suite, proceed as described below.

— *Note:* on the Archimedes 440 the Welcome Suite software *is* on the hard disc.

- 1 Make sure the computer system is properly put together, all connectors firmly installed.
- 2 Turn the computer on.
- 3 Hold the Welcome Disc with the insert-arrow side up. The disc enters the drive in the direction the arrow is pointing. (See the chapter, **TAKING CARE OF DISCS** for detailed information on how to use floppy discs.)
- 4 Insert the disc in the slot. It enters at a slight downward slant. Push it in until it 'clicks' into place and the disc eject button pops out.
- 5 Position the pointer on the *disc* icon and click **select**. The screen appears as follows:

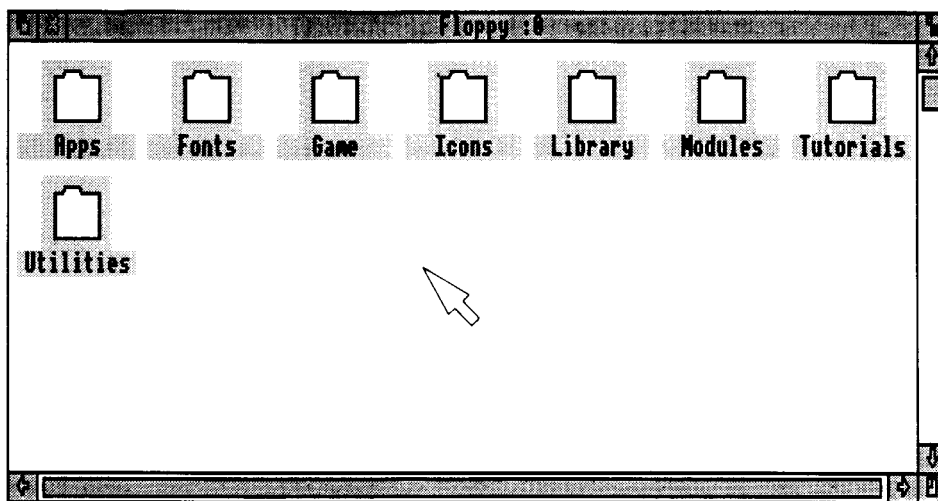

The Welcome Suite programs are accessed from this window.



Each program is contained in a file or folder, represented as follows:

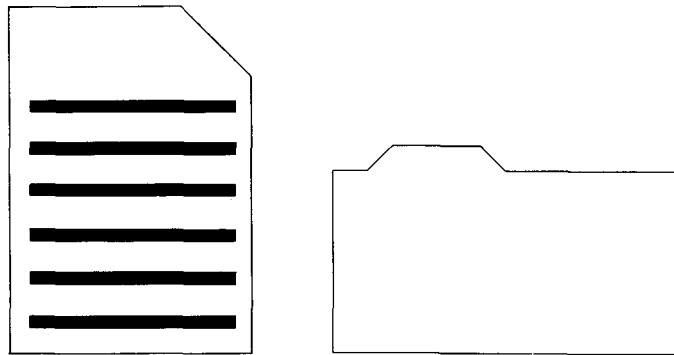

The first drawing represents a file. The second represents a folder or directory (folders and directories are synonymous). Organising information into files and directories is a function of the Advanced Disc Filing System. Directories and files are described in the **User Guide** and in the **ADFS** tutorial. The following explanation discusses the contents of each file and folder: the programs in the Welcome Suite.

### **Apps**

This folder contains applications *Font Alias*, *Font Designer*, *Music Editor*, and *Painting*. To look at the contents of a folder, position the pointer on the folder icon and double-click **select**.

*UserFonts*, *UserTunes* and *UserPics* (also found in the *Apps* folder) relate to these four applications.

*FontAlias*: This application allows you to smooth out jagged edges on characters created using the *Font Designer*. Details of its use are discussed in the chapter, **USING THE FONT DESIGNER**.

*FontDes*: This is the Font Designer application which allows you to design your own fonts. Details of its use are discussed in the chapter, USING THE FONT DESIGNER.

*MusicEd*: This is the Music Editor application. You can use it to transcribe and play back sheet music on the computer. Its operation is described in the chapter, USING THE MUSIC EDITOR.

*Painting*: This is the Paint application. You can use it to draw and paint as described in the chapter, USING PAINT.

*UserFonts*: This folder contains the fonts created by using the Font Designer. When you position the pointer on this option and double-click **select**, it lists the names of fonts you have saved. When you click **menu**, the File menu appears, from which you can copy, move, delete or rename the fonts you have created. (See the chapter, MANAGING DISCS for more information on the *File menu*.)

*UserPics*: This folder contains pictures created with Paint. To list the names of pictures you have saved, position the pointer on this option and double-click **select**. When you click **menu**, the *File menu* appears, from which you can copy, move, delete or rename them. An example picture showing the 'A' character from the Archimedes logo is provided for you to load into Paint. This picture is saved as a file called `ARC` in the *UserPics* folder.

*UserTunes*: This folder contains the tunes created using the Music Editor. When you position the pointer on this option and double-click **select**, it lists the names of the tunes you have saved. When you click **menu**, the *File menu* appears, from which you can copy, move, delete or rename tunes.

Examples are provided for you to try out the Music Editor. They are saved as files called `Tune1` and `Tune2` in the *UserTunes* folder.

## **Fonts**

This folder contains the fonts which determine the typefaces used for screen text. You do not need to access it.

## Game

This folder contains two files: a three-dimensional game called *Lander* and the programs (*GameCode*) which run the game. To run Lander on the Archimedes 310 or 400 series Archimedes, proceed as follows:

- 1 Position the cursor on the folder labelled *Game*.
- 2 Double-click **select**. The contents of the folder are displayed.
- 3 Position the cursor on the folder labelled *Lander* and double-click **select**.

A launching pad, space shuttle and three rockets appear on a landscape.

- *Note:* do not choose the *GameCode* option. It contains the programs which ran *Lander*.

To run Lander on an Archimedes 305, proceed *as* follows:

- 1 Leave the desktop by positioning the pointer on the Exit box on the icon bar and press and release **select**.
- 2 Position the pointer on Yes and press and release **select**.
- 3 Type \*USEGAME[Return]
- 4 Press [Ctrl][Break]
- 5 Type \*GAME.LANDER[Return]

The game will now load and run.

To return to the desktop after playing the game, take the following steps:

- 1 Press [Esc] or [Ctrl] [Break] to quit the game.
- 2 At the Arthur operating system prompt, type USEDESKTOP[Return]

3 Press [Ctrl][Break] and the desktop will now return.

The object of the game is to fly the shuttle over the landscape, gaining points by destroying any items that appear.

The game is played as follows:

- Launch the shuttle off the pad by clicking **select**.
- Manoeuvre the shuttle by turning the mouse slightly to the left or right, towards you or away from you.
- Keep the shuttle moving by turning the mouse to tilt it and clicking select to emit a jet stream which sends it travelling over the landscape.
- Make the shuttle hover by clicking **menu**.
- Destroy objects by shooting at them with bullets fired from the shuttle. Trigger the bullets by clicking **adjust**.
- Refuel the shuttle by finding your way back to the launching pad and landing for refuelling. The fuel gauge is the red line at the top of the screen.

You begin the game with 500 points, and gain 20 points for every object you destroy. You lose one point for every bullet fired that does not strike a target.

You are allowed three chances to fly the shuttle. If you crash, you are returned to the launching pad. The game ends after the third crash.

When you reach 800 points, rocks begin to fall. You must dodge them as you continue to fly the shuttle.

### **Icons**

This folder contains a file called *Music*. In the Music file are the sprites used in the Music Editor application.

Sprites are graphics characters. In this case they include the notes, rests, bars, clef signs and so on which are part of the program. See the chapter, **SPRITES** in the **User Guide** for more information on sprites.

### **Library**

This folder contains useful utility programs.

The `UseDesktop` and `UseGame` files in this folder are required by Archimedes 305 users when they wish to run the Lander game (see the section **Game** earlier in this chapter).

If you have an Archimedes 400, this folder also contains a BASIC program called `WFORM`. This program is a hard disc formatter and you should not normally need to use it as formatting your hard disc will destroy all data on the hard disc. For information on this program and how to use it, refer to the chapter **HARD DISC FORMATTING**.

### **Modules**

This is a folder in which files are kept that extend the operating system, Arthur, giving extra features to the system.

In order to access these files you must exit the desktop and use typed commands. See the **User Guide** for instructions on how to do so.

*65A rthur*: This is an emulator which allows you to run some of the existing software, written for the BBC Micro and Master-Series Microcomputers, on the Archimedes.

To run the emulator:

- 1 Leave the desktop by clicking select on the EXIT icon.

## 2 Type

```
*RMLOAD $.Modules.65Arthur  
*EMULATEBBC
```

You will now be in an environment which emulates a BBC 6502 second processor and you will be presented with a prompt for BBC BASIC version IV.

In order to leave the emulator and return to the Arthur operating system, type

```
*QUIT
```

While the 65Arthur module is loaded into the machine's memory, you can re-enter the emulator at any time by typing `*EMULATEBBC`

*FPEmulator*: This file contains a floating point emulator. It is used only by compilers.

*RAM\_Basic*: This file contains a version of BBC BASIC which can be run in RAM, making it much faster than BASIC run in ROM. To run *RAM\_Basic*, type

```
*RMLOAD $.MODULES.RAMBasic  
*BASIC
```

### **Tutorials**

This folder contains the three tutorials found on the Welcome Disc:

*ADFSdemo*: This tutorial tells you how the computer organises data on disc and how to use the hierarchical filing system.

*KeyTutor*: This tutorial tells you how to use the keyboard.

*ScreenDemo*: This tutorial tells you about the various screen displays available on the computer

*ADFSdemo* and *KeyTutor* require you to type in answers to questions. After typing an answer, press [Return] unless instructed to do otherwise.

Take the following steps to access a tutorial:

- 1 Position the pointer on the tutorial icon and double-click **select**. The tutorials screen is displayed.
- 2 Position the pointer on the tutorial you require and double-click **select**. The first screen of the tutorial you chose is displayed.
- 3 Follow the instructions given on the screen to work through the tutorial and return to the *main desktop* screen.

### **Utilities**

This folder contains the programs *SEdit* and *Dircopy*.

*SEdit* is the sprite editor which is used to create new sprites or modify existing ones. Details of how the sprite editor works are given in the **User Guide** in the chapter *SPRITES*.

*Dircopy* allows you to copy directories and subdirectories and is particularly useful when you are copying between discs. It is recommended that you become familiar with the structure and terminology of the Advanced Disc Filing System (ADFS) before you try to use this utility as it is designed with the more advanced user in mind. Details of the ADFS can be found in the **User Guide** chapter, *FILING SYSTEMS*.





The Font Designer allows you to design letters and symbols in your own styles and save them together as a font. You can:

- create up to 10 different fonts in memory
- create and save up to 198 individual characters in each font
- recall and amend previously created characters
- create and save up to 16 individual serifs
- attach serifs to individual characters
- create and save up to 16 different pens
- use one or more pens on each letter.

This chapter is a simple introduction to the Font Designer. The main steps to follow when creating a font are:

- 1 Create a 'skeleton' character.
- 2 Create a pen or, once you have created several pens, choose a pen from the existing menu of pens.
- 3 Fill in the skeleton character with the pen.
- 4 Create a serif (if the character requires a serif) or, once you have created several serifs, choose one from the existing menu of serifs.
  - *Note:* a serif is a decorative line which appears at the end of the main stroke of a letter in certain typefaces.
- 5 Attach the serif to the character.
- 6 Save the character in the font for future reference.
- 7 Create any other characters you need to complete the font, following steps 1 to 6 above
- 8 Perform a function known as 'anti-aliasing' that smooths out jagged edges with shades of grey, thus creating readable characters in very small point sizes.

The section, **Creating characters** tells you how to perform the functions necessary to achieve steps 1 to 7. The section, **Anti-aliasing** tells you how to perform step 8.

## CREATING CHARACTERS

The Font Designer is one of the programs in the Welcome Suite. It is accessed through the desktop.

The explanations below assume you are beginning from the Font Designer's *Whole font* menu. To reach the *Whole font* menu, take the following steps:

- 1 Begin from the main *desktop* screen.
- 2 Position the pointer on the *disc* icon and click select. A window showing a catalogue of your disc appears.
- 3 Position the pointer *Apps* folder and double-click select. A window entitled *Apps* is displayed.
- 4 Position the pointer on *FontDes* in the *Apps* window and double-click **select**. A window entitled *Whole font* is displayed across the top of the screen. It is from this window that you begin the steps to create a character.

There are five aspects to creating characters which include creating a character using straight lines, creating and using a pen, saving fonts and pens, making curved lines, creating serifs and attaching them to letters.

### Using straight lines

To create a character composed entirely of straight lines, proceed as follows:

- 1 Position the pointer just to the right of the `Font :` message at the top of the *Whole font* screen and click **select**. A caret will appear and you can now type in a name for your font. Press [Return] when you have entered the name.

- 2 Position the pointer on one of the boxes containing a character and double-click select. A window entitled Char full appears on the screen.
- 3 Position the pointer to the right of the Char : message at the top of the Char full window and click select. A caret will appear and you can now type in a name for the character. Press [Return] when you have entered the name.

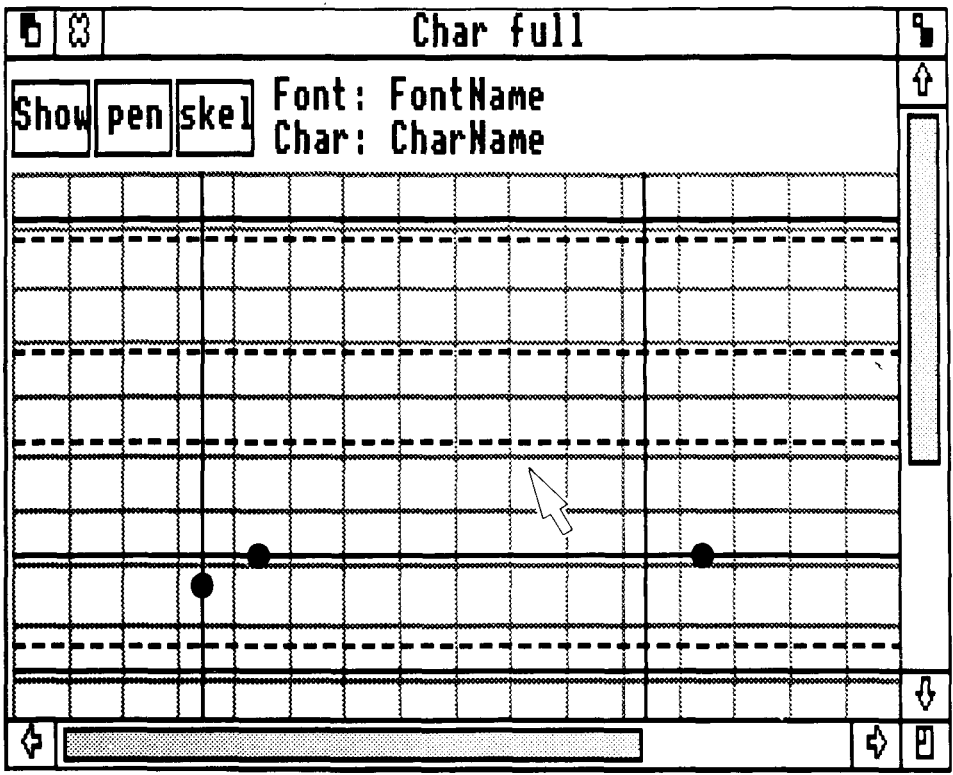

- 4 Position the pointer on the box entitled *skel* and click **select**. A window entitled *Char skel* appears on the screen.

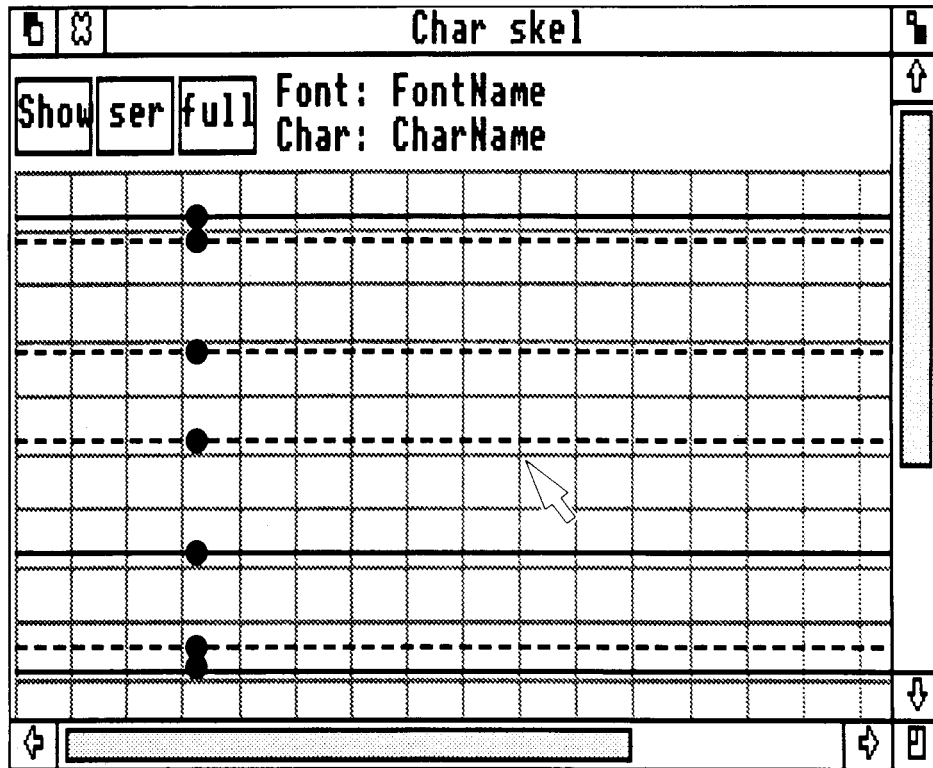

- 5 Enlarge the *Char skel* window to full screen size for ease of use. It is in this window that you create a character.
- 6 Position the pointer on the window at the point where you want to begin drawing a line to create the character.

- *Note:* the three solid lines which appear darker than the other lines on the grid represent the boundaries of the character. The upper line is the upper boundary, the middle line is the lower boundary. The lowest solid line is the descender line.

The broken lines can be moved by positioning the pointer on a dot on the line and pressing and holding **adjust** while dragging the line up or down. These lines are provided to give reference points when you are designing characters.

- 7 Press and hold **select**. A dot appears where the pointer is positioned. Keeping **select** pressed, move the pointer to the point where you wish the line to end. A thin line follows the pointer.
- 8 Release **select**. A dot appears at the end of the line, and the line remains on the screen stretched between the first and last dot.
- 9 Draw the remaining lines of the character by following steps four to six.
- 10 Return the *Char skel* window to its original size when the character is complete.
- 11 A copy of the character appears in the *Char full* window.

You have now created a 'skeleton' character using straight lines. You can save the character as it is, or 'flesh it out' by going over it with a pen.

### Creating a pen

To create a pen, proceed as follows:

- 1 Position the pointer on the box marked *Pen* in the *Char full* window, click and release **select**. The *Pen menu* window appears on the screen.
- 2 Position the pointer on a box in the *Pen menu* window.
- 3 Double-click **select**. The *Edit pen* menu appears.

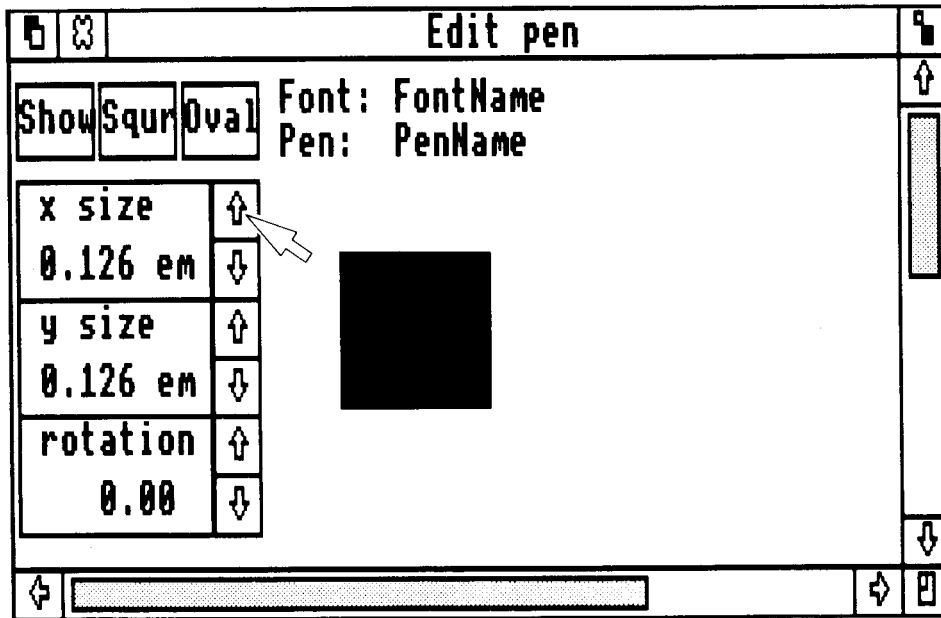

- 4 Create a pen by positioning the pointer on one of the boxes containing an up or down arrow and pressing and holding **select**. Notice the black square to the right of the arrows changes in size as you keep **select** pressed.
- 5 Experiment with each of the arrows until you achieve the size of pen you require by moving the pointer to each of the arrows and pressing and holding **select**. Change the shape of the pen to oval or square by positioning the pointer on the *Oval* or *Sqr* box and clicking **select**.
- 6 When you are satisfied with the shape of the pen, position the pointer on the *Show* box in the *Edit pen* window and click **select**. The pen appears in a box on the *Pen menu*.
- 7 To create another pen, reposition the pointer in the *Pen menu* window and repeat steps 3 to 6 above.

- 8 Quit the *Edit pen* window.

### Using a pen

To use a pen, you will need to:

- 1 Create a new pen, or select a pen previously created. A new pen *is* ready to use after being saved in the *Pen menu* box. Select a previously created pen from the *Pen font* by positioning the pointer on the box containing the pen you require and clicking **select**.
- 2 Position the pointer on a line of the character in the *Char full* window.
- 3 Click **select**. The pen chosen re-draws the line on the character.
- 4 Position the pointer on each line of the character and click **select** until the entire character is re-drawn with the pen.
- 5 Position the pointer on the *Show* box and click **select**. The character appears in a box in the *Whole font* window.
- 6 Click **select** on the quit boxes on the *Char full* and *Char skel* windows.

Once you have designed each character in your font, you are ready to save the font and pens you have created.

### Saving a font and pen

To save a font and pen, take the following steps:

- 1 Position the pointer on the *Disc* box in the *Whole font* window and click **select**.
- 2 Type the name of the file into which the font you have designed is to be saved. The name must not be more than ten characters long.
- 3 Position the pointer on the *Save* box.

- 4 Click **select**. The font is saved in the directory *UserFonts*. The pen is saved at the same time. Whenever you select the *Pen menu* option, the pen is displayed in a box on the menu.

### **Copying a character**

You can copy characters that you have created, from one box in the *Whole font* window to another as follows:

- 1 Position the pointer on the box containing the character you wish to copy.
- 2 Press and hold **select**. The box is outlined by a moving dotted line.
- 3 Keeping **select** pressed, move the pointer to another box into which you want to copy the character. The dotted outline moves with the pointer.
- 4 Release **select**. The character is copied into the new box.

Follow the same procedure to copy a pen (or serif) from one box on the *Pen menu* (or *Serif menu*) to another.

### **Using curved lines**

To draw a character with curved lines, you should:

- 1 Draw the character as if you were composing it of straight lines. Follow the steps given in the section, **Using straight lines**. For example, draw a 'C' as shown in the drawing below. Make sure you leave enough room around the letter to form curves later.



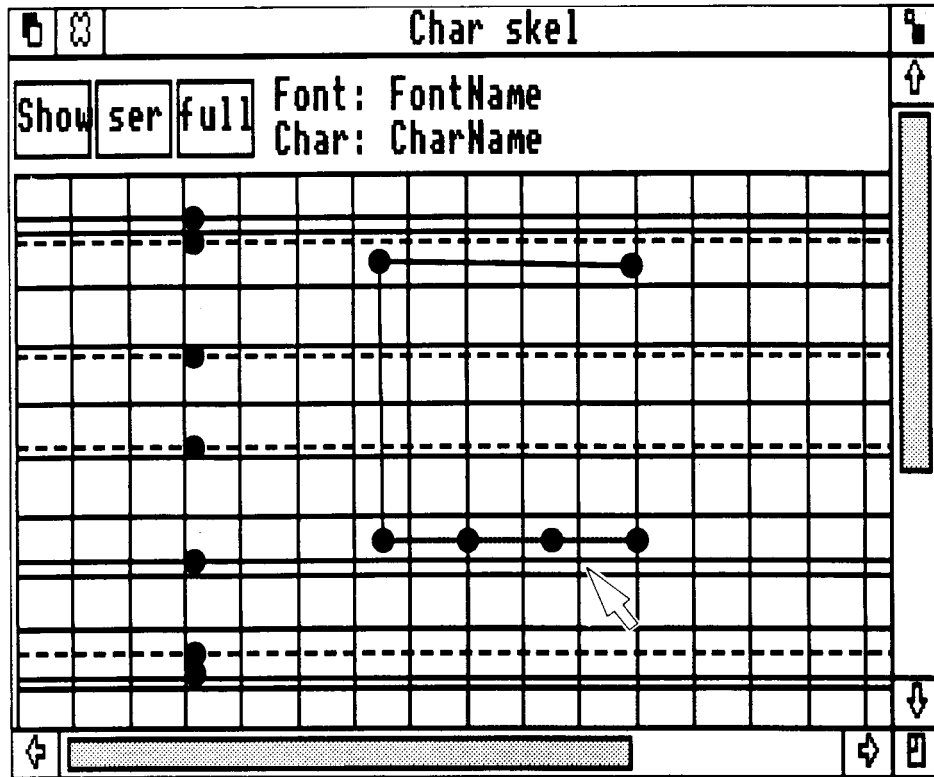

When you finish drawing the character, notice that one line may be in a different colour from the others and may contain more dots. This is the 'active' line. Any line that is active can be moved to form a curve.

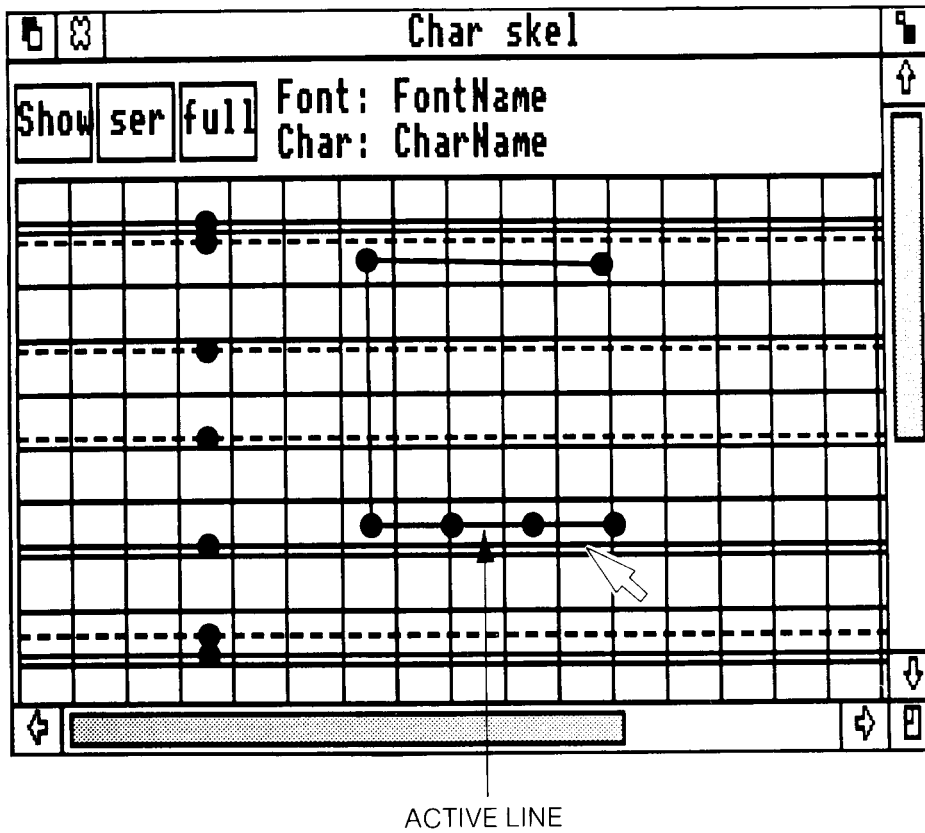

- 2 Position the pointer on one of the lines making up the 'C'.
- 3 Click **adjust** to make the line the active line.
- 4 Position the pointer on one of the dots on the active line, press and hold **adjust**.
- 5 Keeping **adjust** pressed, move the pointer, taking the dot with it. The line is dragged in the direction of the dot, forming a curve. Keep dragging the line until the curve you require is formed as shown in the drawing below.

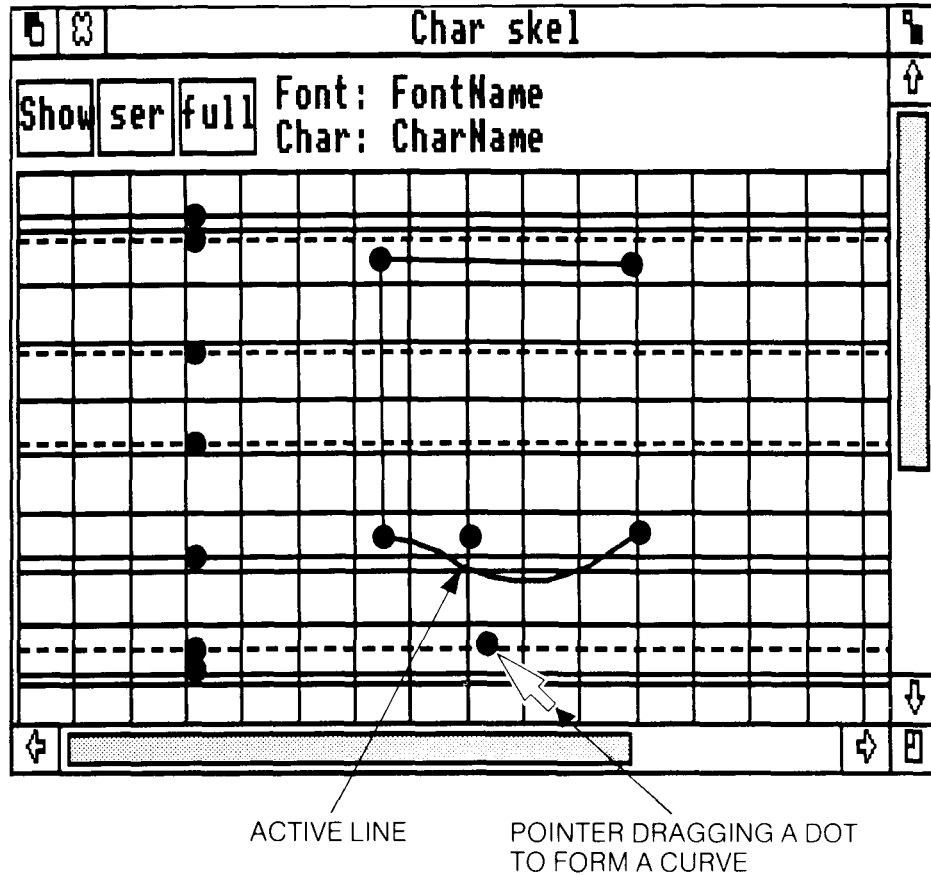

- 6 Release **adjust** to set the curve in position.
- 7 Continue forming curves by following steps 2 to 6 above until the character is formed.

You have now created a 'skeleton' character using curved lines and are ready to fill it in with a pen as described previously in the section, **Using a pen**.

## Creating a serif

To create a serif, you will need to:

- 1 Follow the steps required to display the *Char full* and *Char skel* windows.
- 2 Position the pointer on the *ser* box found on the *Char skel* window and click **select**. The *Serif menu* window appears on the screen.
- 3 Position the pointer on a box in the *Serif menu* window.
- 4 Double-click **select**. The *Serif full* window appears.
- 5 Position the pointer on the box entitled *skel* on the *Serif full* window and click **select**. The *Serif skel* window appears.
- 6 Draw a serif using the same methods you use to create a character. When you have finished, move the pointer to the *Serif full* window. A copy of the serif appears in the *Serif full* window.
- 7 Fill in the lines of the serif with a pen.
- 8 Position the pointer on the *Show* box in the *Serif full* menu and click **select**. The serif appears in a box on the *Serif menu* window.
- 9 Quit the *Serif skel* and *Serif full* windows.

### Attaching a serif to a letter

To attach a serif to a letter, proceed as follows:

- 1 Display the character requiring serifs in the *Char full* and *Char skel* windows.
- 2 Position the pointer on the character in the *Char skel* window at the point where you want the serif to be attached. The pointer must rest on a dot.
- 3 Click **menu**. A menu of options appears on the screen.
- 4 Position the pointer on the *Serif* option and click **select**. The serif appears on the letter at the point chosen in step two.
- 5 Continue the above steps until all serifs are attached.
- 6 Move the pointer to the *Char full* window and the character with serifs attached will be displayed.
- 7 Position the pointer on the *Show* box in the *Char full* window and click **select**.
- 8 Quit the *Char full* and *Char skel* windows.

### DELETING A LINE

It is very easy to delete lines and replace them at any time. You can do this using the steps given below:

- 1 If you are not creating a character, display the character containing the line you wish to delete in the *Char skel* window. Otherwise the character you are working on is already displayed.
- 2 Position the pointer on the line you wish to delete.
- 3 Click **menu**. A menu entitled *Alter line* appears on the screen.

- 4 Position the pointer on the *Delete* option and click **select**. The *Alter line* menu disappears and the line selected is deleted.

## ANTI-ALIASING

Anti-aliasing is a function which allows you to create characters using a small point size without them becoming illegible. It smooths out the tiny jagged edges on a character with shades of grey, making them easier to read. Once the font has been anti-aliased, it can be used by the Font Manager (see the **Programmer's Reference Manual** for information).

In order to use anti-aliasing, you should:

- 1 Create characters and save them in a font, following the steps given in the section above: Creating a character.
- 2 Quit the Font Designer and return to the *main desktop* screen. Then position the pointer on the *disc* icon and click **select**.
- 3 Position the pointer on the *Apps* option and double-click **select**, and then position the pointer on the *FontAlias* option and double-click **select**. The following window is displayed:

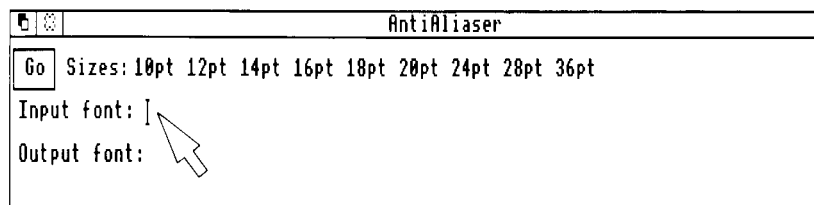

- 4 Type the name of the file containing the font you want to anti-alias and press [Return]

- 5 Type the name of the file which will contain the font after it has been anti-aliased and press [Return]
- 6 Position the pointer on the point sizes you require and click **select**.
- 7 Position the pointer on *Go* and double-click **select**. A box appears in the top right-hand corner. Each letter contained in the font designated appears in the box (one at a time) and is shaded in grey. This allows any tiny jagged edges to be smoothed out, making the letter more legible when printed. A copy of each character, as it will actually appear on the screen, also appears at the top left-hand corner of the box.
- 8 Quit the anti-alias program when all characters in the font have been through the procedure. The font is automatically saved in the directory `FONTS` in the output file designated in step 5, and the font will be given the same name as the output file.





The Music Editor enables you to transcribe music onto the computer, creating and saving musical scores, recalling and amending previously entered scores, and allocating any of the eight channels to any of the eight staves.

This chapter tells you how to use the Music Editor, but assumes that you are familiar with the terminology used in musical scores. You do not always need to follow the sequence of steps as they appear here. It is recommended, however, that you begin by working through the steps as they are given. You can then quickly become familiar with how the Editor functions, and so discover how best to use it to suit your own requirements.

Once you have worked through the steps, use each section for reference in case you need to remind yourself of an individual function.

## BEFORE YOU BEGIN

The Music Editor is one of the programs in the Welcome Suite. It is accessed through the desktop. Take the following steps:

- 1 Begin from the *main desktop* screen.
- 2 Position the pointer on the *disc* icon.
- 3 Click **select**. The menu which appears includes an option entitled *Apps* (Applications).
- 4 Position the pointer on the *Apps* option.
- 5 Double-click **select**. The *Apps* menu is displayed.
- 6 Position the pointer on the *MusicEd* option.
- 7 Double-click **select**. In a few seconds a window entitled *The Score* and a menu entitled *Maestro* are displayed.

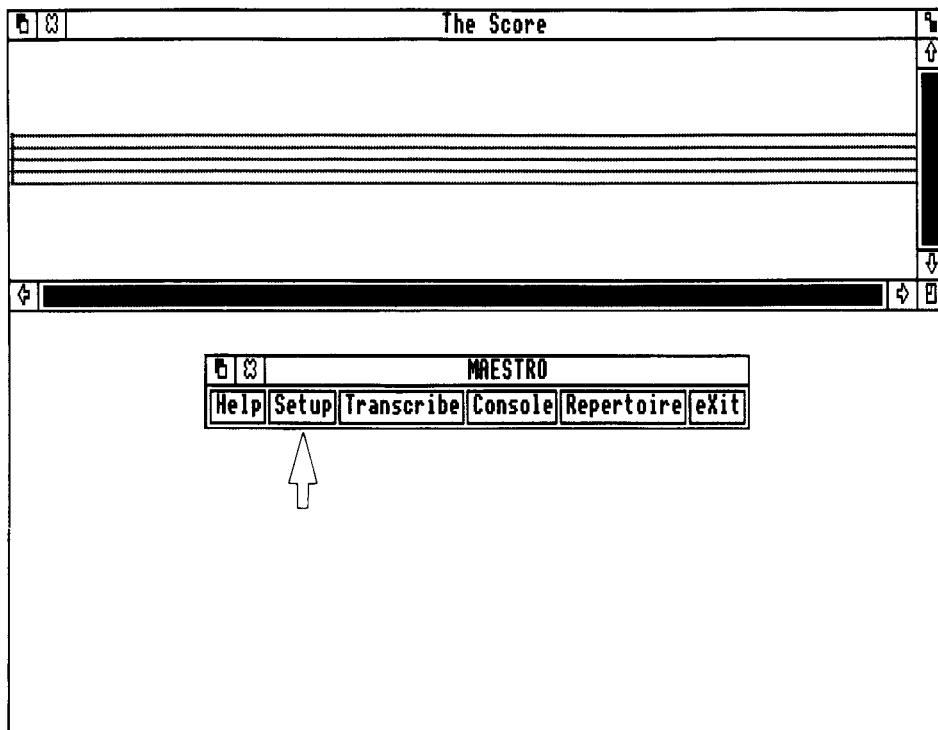

It is from the *Maestro* menu that you begin the steps to transcribe music.

## SETTING UP

The setting up process is divided into the following parts:

- Set up staves and tempo
- Select instruments
- Choose the clef(s)
- Assign a key signature
- Establish the time signature.

The description below discusses each part in the order listed above. It is not, however, always necessary to follow this order. For example, you can establish the time signature before you choose a clef or key. Once you know how the Music Editor works, you can decide how best to organise your own set-up procedure.

**Setting up staves**

To set up staves using the following instructions you should begin at the *Maestro* menu:

- 1 Position the pointer on the Setup option on the *Maestro* menu.
- 2 Click **select**. The *Setup* menu is displayed.
- 3 Position the pointer on the *Staff* option on the *Setup* menu.
- 4 Click **select**. The *Staff* menu appears.
- 5 Position the pointer on the option you require. The choices are as follows:
  - *Voice* only
  - *Keyboard* only
  - *Voice and Keyboard*
  - *Chorus* only.
- 6 Click **select**. The staff you choose is displayed.

- *Note: Voice* represents the melody. *Keyboard* represents an accompaniment. *Chorus* represents the four parts: soprano, alto, tenor and bass.

Any of the four options can be used with the *Single* or *Double* percussion options found on the same menu.

If the *Stave*, *Setup* and *Maestro* menus disappear behind the *Score* window, position the pointer on the *back* icon in the *Score* window and click **select**. The menus reappear.

- 7 Position the pointer on *Single* (single percussion) or *Double* (double percussion), depending on the percussion you require.
- 8 Click **select** to choose the desired percussion.
- 9 Quit the *Stave* menu.

### **Setting the tempo**

Take the following steps to set the tempo. Begin at the *Maestro* menu:

- 1 Position the pointer on the *Setup* option on the *Maestro* menu.
- 2 Click **select**. The *Setup* menu is displayed.
- 3 Position the pointer on the *Tempo* option of the *Setup* menu.
- 4 Click *select*. The *Tempo* menu is displayed.
- 5 Position the pointer on the option you require.
- 6 Click **select** to choose the tempo.
- 7 Quit the *Tempo* menu.

**Selecting instrumentation**

To select the instrumentation you require, proceed as follows:

- 1 Position the pointer on the *Setup* option on the *Maestro* menu.
- 2 Click **select**. The *Setup* menu is displayed.
- 3 Position the pointer on the *Instrument* option of the *Setup* menu.
- 4 Click **select**. The *Instrument* menu is displayed. The options are:

<i>Percussion</i>	Noise	Fortississimo	Centre
	Snare	Fortissimo	Centre left
	Medium	Forte	Left
	Soft	Mezzo-forte	Full left
<i>String Lib</i>		Mezzo	Full right
	Hard	Mezzo-piano	Right
	Steel	Piano	Centre right
	Pluck	Pianissimo	
<i>WaveSynth</i>	Soft	Pianississimo	
	Beep		

- 5 Position the pointer on the first instrument box.
- 6 Click **select** to choose the instrument, volume and stereo position you require.
- 7 Repeat steps 5 and 6 for each stave you require.
- 8 Quit the *Instrument* menu.

### Selecting volume

To select the overall volume that your music is to be played at, proceed as follows:

— *Note:* the volume of each individual instrument is set from the *Instrument* menu as described above.

- 1 Position the pointer on the *Setup* option in the *Maestro* menu.
- 2 Click **select**. The *Setup* menu is displayed.
- 3 Position the pointer on the *Volume* option of the *Setup* menu.
- 4 Click **select**. The *Volume* menu is displayed.
- 5 Position the pointer on the volume option you require.
- 6 Click **select** to choose the volume.
- 7 Quit the *Volume* menu.

### Choosing the clef

Take the following steps to choose the clef(s). Begin at the *Maestro* menu:

- 1 Click on the *Full screen* box on the *Score* window and click **select**.
- 2 Redisplay the *Maestro* menu by clicking **menu**.
- 3 Position the pointer on the *Transcribe* option on the *Maestro* menu and click **select**. The *Transcribe* menu is displayed.
- 4 Position the pointer on the *Clef* option and click **select**. The *Clef* menu is displayed.
- 5 Choose a clef (treble, alto, tenor or bass) by positioning the pointer on the icon representing the option you require and clicking **select**.

- 6 Move the pointer to the staff on which the *clef* icon is to rest.
- 7 Click **select**. The icon you have chosen appears on the staff.
- 8 Quit the *Clef* menu.

### Assigning a key

To follow the instructions for assigning a key signature, you need to begin at the *Transcribe* option of the *Maestro* menu:

- 1 Position the pointer on the *Key* option on the *Transcribe* menu and click **select**. The *Key* menu is displayed.
- 2 Select sharps or flats by positioning the cursor on the box containing the sharp icon.
- 3 Click **adjust** to toggle between the sharp and flat icons, leaving the icon you require displayed.
- 4 Select the correct number of sharps or flats by positioning the pointer on the box containing the '0'.
- 5 Click **adjust** until the required amount is reached. Leave the number displayed.
- 6 Position the pointer on each box of the *Key* menu. Click **select** on both boxes to select the number of sharps or flats you have chosen.
- 7 Move the pointer to the staff which is to contain the key signature and click **select**. The key signature appears next to the *clef* icon on the staff.
- 8 Quit the *Key* menu.

### **Establishing the time**

Take the following steps to establish a time signature. Begin at the *Transcribe* option of the *Maestro* menu:

- 1 Position the pointer on the *Time* option on the *Transcribe* menu and click **select**. The *Time* menu is displayed.
- 2 Position the pointer on the number in the upper half of the *Time* menu.
- 3 Click **adjust** to choose the upper number of the time signature. Leave the number required displayed.
- 4 Position the pointer on the number in the lower half of the *Time* menu.
- 5 Click **adjust** to choose the lower number of the time signature. Leave the number required displayed.
- 6 Position the pointer on each box of the *Time* menu. Click **select** on both boxes to select the time signature you have chosen.
- 7 Move the pointer to the staff which is to contain the time signature and click **select**. The time signature appears on the staff.
- 8 Quit the *Time* menu.

The setup procedure is now complete and you are ready to begin transcribing music.



## TRANSCRIBING MUSIC

The discussion below tells you how to transcribe music onto the screen, scroll the score to the left and right and edit a previously transcribed score.

### How to transcribe music

To transcribe music onto the screen, you need to:

- 1 Prepare for transcribing as described in the section above: **Setting up**.
  - 2 Position the pointer on the *Note* option on the *Transcribe* menu.
  - 3 Click **select**. The *Note* menu is displayed.
  - 4 Position the pointer on the *Other* option on the *Transcribe* menu.
  - 5 Click **select**. The *Other* menu is displayed.
- *Note*: it is advisable to keep the *Note* and *Other* menus displayed while you are transcribing. When they first appear, they may be overlapping or obscuring part of the screen that you wish to see. Move each menu in turn to a more convenient screen location by positioning the pointer on the *Move window* section of the menu's title bar and pressing and holding **select**. Keep **select** pressed while you move the pointer, dragging the menu to another location. Release select to secure the menu in the new position.

You may also want to make more room on the screen by quitting the *Transcribe* and *Maestro* menus. To recall the *Maestro* menu (and from it the *Transcribe* menu), click **menu** at any time.

- 6 Choose a note by positioning the pointer on the icon you require on the *Note* menu and clicking **select**.
- 7 Set the note icon on the staff by moving the pointer to the line or space on which you want the note to appear.

- 8 Click **select** to secure the note on the stave.
  - *Note:* when you choose an icon from the *Note* menu, the icon follows the pointer around the screen even after you perform step 8. This facility allows you to continue entering the note (or any of the icons selected from the *Note* menu) without constantly having to select it from the *Note* menu. To change notes, choose another icon from the menu. To remove a 'roving' icon, click **adjust**.
- 9 Follow the procedure described in steps 6 to 8 to position the rests, sharps, flats, ties and bars found on both the *Note* and *Other* menus.

### **How to scroll the score**

Before you begin the scroll procedure, note the following points:

If you are transcribing music, when you reach the end of the stave, you need to scroll the *Score* window to the left to allow you to continue transcribing.

You need to scroll the *Score* window to the left and right to view previously transcribed music.

You must insert bars in your score. If you do not do so, the *Scroll* function does not work.

*Scrolling to the left:* To scroll the *Score* window to the left, you need to:

- 1 Display the *Maestro* menu on the screen by clicking menu. (If the *Maestro* menu is already displayed, omit this step.)
- 2 Position the pointer on the *Console* option.
- 3 Click **select**. The *Console* menu is displayed.
- 4 Position the pointer on the *Forward* option.
- 5 Click **select**. The score is scrolled one bar to the left of the window.

Choosing *Forward* causes the window to scroll bar by bar every time you click **select**.

You can also choose the *End* option. Selecting *End* causes the window to scroll to the end of the score.

*Scrolling to the right:* To scroll the Score window to the right, take the following steps:

- 1 Display the *Maestro* menu on the screen by clicking **menu**. (If the *Maestro* menu is already displayed, omit this step.)
- 2 Position the pointer on the *Console* option.
- 3 Click **select**. The *Console* menu is displayed.
- 4 Position the pointer on the *Rewind* option.
- 5 Click **select**. The score scrolls one bar to the right of the window.

Choosing *Rewind* causes the window to scroll bar by bar every time you click **select**.

You can also choose the *Begin* option. Selecting *Begin* causes the window to scroll to the beginning of the score.

### **How to edit the score**

The instructions below tell you how to edit the score by inserting and deleting musical notation.

*Inserting notation:* To insert notation into a previously transcribed score, take the following steps:

- 1 Display the *Note* and *Other* menus on the screen.
- 2 Select the icon representing the notation you require from the *Note* or *Other* menu by positioning the pointer on the icon and clicking **select**.

- 3 Move the pointer to the position on the staff on which you want the icon to appear.
- 4 Click **select** to secure the icon on the staff. All notation to the right of the insert moves to make room for the new icon.

*Deleting notation:* To delete notation from a previously transcribed score, you need to:

- 1 Display the *Note* and *Other* menus on the screen.
- 2 If the notation you wish to delete is found on the *Note* menu, select any icon from the *Note* menu by positioning the pointer on the icon and clicking **select**.  
  
If the notation you wish to delete is found on the *Other* menu, select any icon from the *Other* menu by positioning the pointer on the icon and clicking **select**.
- 3 Position the 'roving' icon chosen in step 2 on the notation you wish to delete. A white space appears where the two icons coincide.
- 4 Click **select**. The notation underneath the 'roving' icon is deleted from the staff. All notation to the right of the deletion moves to the left to fill in the space.

*Clearing currently displayed score:* to clear a score that you are currently transcribing or a score that you have loaded into the Music Editor from disc, you need to:

- 1 Display the Maestro menu by clicking **menu**. (If the *Maestro* menu is already displayed omit this step.)
- 2 Position the pointer on the *Setup* option and click **select**. The *Setup* menu is displayed.
- 3 Position the pointer on the *Clear* option and click **select**. The currently displayed score will be cleared from the Music Editor.

- *Note:* if you are in the process of transcribing a piece of music and you select the **Clear** option, you will be given the warning `Abandon current score?` before the current score is cleared. This gives you the chance to save the score you are transcribing before it is cleared (see the section, **Saving and Recalling Music** later in this chapter). If you wish to go ahead and clear the music then click **select** again.

## PLAYING MUSIC

Once music is transcribed on the screen, you can play it back to hear how it sounds. Before you begin, note the following points:

- If you start playing with the beginning of a piece of music displayed in the *Score* window, the entire piece is played through to the end.
- If you start playing after scrolling the stave so that the beginning of a piece of music is no longer displayed in the *Score* window, playing commences from the first bar shown in the window and continues to the end of the entire piece.
- If you stop playing before the end of the piece, the score scrolls as many bars to the left as have been played.

Now, proceed as follows:

- 1 Follow the steps given in **Setting up** and **Transcribing** music to transcribe a musical score onto the screen, or load a piece of music saved earlier (see the section, **Saving and recalling music**).
- 2 Display the *Maestro* menu on the screen by clicking **menu**. (If the *Maestro* menu is already displayed, omit this step.)
- 3 Position the pointer on the *Console* option on the *Maestro* menu.
- 4 Click **select**. The *Console* menu is displayed.
- 5 Position the pointer on the *Play* option on the *Console* menu.

- 6 Click **select**. The computer plays the music selected.

You can stop playing at any time by positioning the pointer on the *Stop* option on the *Console* menu and clicking **select**.

## SAVING AND RECALLING MUSIC

Once a piece of music has been transcribed onto the computer, you can easily save and recall (load) it at will.

### **Saving music**

To save a piece of music transcribed on the screen, follow the steps given below:

- 1 First transcribe a musical score onto the screen using the instructions given in **Setting up and Transcribing music**.
- 2 Display the *Maestro* menu on the screen by clicking **menu**. (If the *Maestro* menu is already displayed, omit this step.)
- 3 Position the pointer on the *Repertoire* option on the *Maestro* menu.
- 4 Click **select**. The *Repertoire* menu is displayed.
- 5 Position the pointer on the *Catalogue* option and click **select**.
- 6 Position the pointer on the blank line at the top of the *Catalogue* window and click **select**. A caret will appear on this line.
  - *Note:* when the *Catalogue* window is selected you will see a list of all the pieces of music that have previously been saved, eg the examples provided on the Welcome Disc, *Tune1* and *Tune2*.
- 7 Type the name of the music you are saving. It can contain up to ten characters. Press [Return]

- *Note:* be careful not to save your new piece of music with the same file name as a previously saved piece, or your original file will be overwritten and lost. You will be given a warning on screen if you try to do this.
- 8 Position the pointer on the *Save* option on the *Repertoire* menu.
- 9 Click **select**. The program is then saved to disc in the directory *UserTunes* which is a subdirectory of *Apps*.

## Loading music

To load a previously saved piece of music, follow the steps given below:

- 1 Display the *Maestro* menu on the screen by clicking **menu**. (If the *Maestro* menu is already displayed, omit this step.)
- 2 Position the pointer on the *Repertoire* option on the *Maestro* menu and click **select**. The *Repertoire* menu is displayed.
- 3 Position the pointer on the *Catalogue* option on the *Repertoire* menu and click **select**. The *Catalogue* window will be displayed.
- 4 Position the pointer on the file name of the piece of music you wish to load and click **select**. The background colour will change around the file name selected.

- 5 Position the pointer on the *Load* option on the *Repertoire* menu.
- 6 Click **select**. The music you have chosen is loaded and displayed on the screen.
- 7 Quit the *Catalogue* window and the *Repertoire* window.

To delete a piece of saved music, follow the steps given below:

- 1 Display the *Maestro* menu on the screen by clicking **menu**. (If the *Maestro* menu is already displayed, skip this step.)
- 2 Position the pointer on the *Repertoire* option and click **select**. The *Repertoire* menu is displayed.
- 3 Position the pointer on the *Catalogue* option in the *Repertoire* menu and click **select**. The *Catalogue* window will be displayed.
- 4 Position the pointer on the file name of the piece of music you wish to delete and click **select**. The background colour will change around the file name selected.
- 5 Position the pointer on the *Delete* option on the *Repertoire* menu and click **select**.
- 6 A message to confirm whether or not you really wish to delete the file will be displayed. Click **select** to confirm the deletion. The file name will be removed from the *Catalogue* window.
- 7 To leave the Music Editor program, click **select** on the *Exit* box in the *Maestro* menu.



Paint is an application which enables you to create graphics by using the capabilities of the Archimedes to design, draw, paint, mix colours and fill in shapes with colour, choosing from a variety of options.

Paint is very straightforward. Once you get started, you will find it easy to use the program. This chapter tells you how to begin, and gives a brief description of the options available.

## BEFORE YOU BEGIN

Paint is one of the programs in the Welcome Suite. Access it through the desktop as follows:

- 1 Begin from the *main desktop* screen.
- 2 Position the pointer on the *disc* icon.
- 3 Click **select**. The window that appears displays a catalogue of the files and directories on the disc.
- 4 Position the pointer on directory *Apps*.
- 5 Double-click **select**. The *Apps* window appears.
- 6 Position the pointer on the *Painting* option in the *Apps* window.
- 7 Double-click **select**. In a few seconds a window entitled *Arm Paint* is displayed.

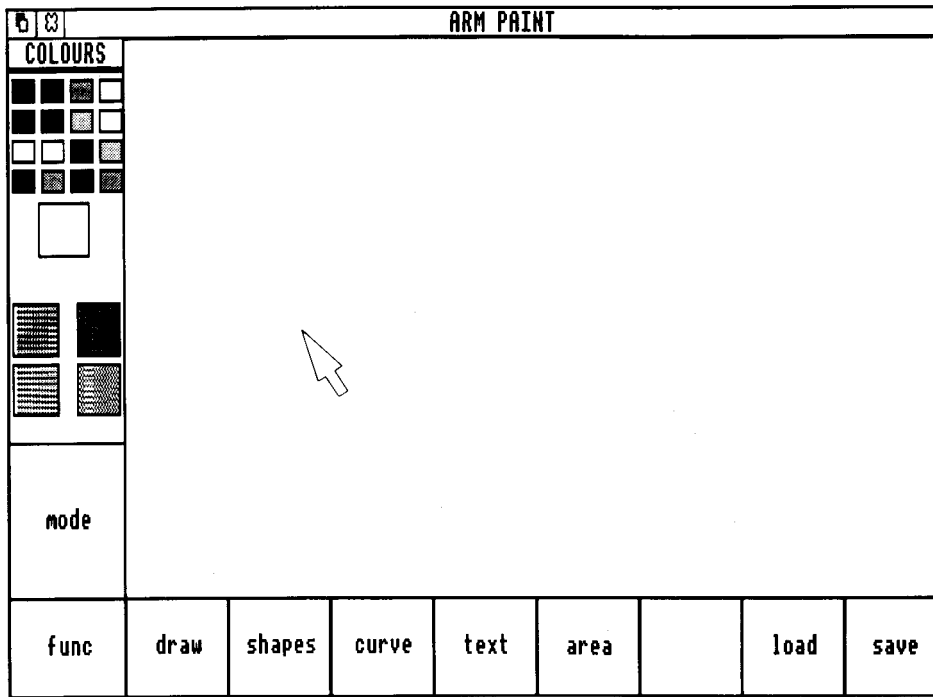

## DRAWING WITH PAINT

Before you begin drawing, note the following points regarding Paint:

The 'drawing board' is the large section covering most of the screen. The text along the bottom and left side of the screen represents available options.

You cannot paint if a window other than the *Arm Paint* window is displayed. You must quit it first. For example, when you select a brush, a *Brushes* window appears. After choosing your brush you must quit the *Brushes* window or you cannot use the brush on the screen.

The box in the lower left-hand corner of the screen always displays the name of the menu containing the options you are using.

When you activate a menu or option, the box containing the menu or option changes colour to show it is in use.

The discussion below includes a brief description of each of the options available. To activate any option, position the pointer on the box containing the option you require and click **select**.

### **Func**

This is the function menu. It is from *func* that you choose other menus containing various options with which you draw and paint. For example, choose *shapes* if you want to draw squares or rectangles; choose *draw* if you want to use a brush.

### **Draw**

To activate *draw*, position the pointer on the box containing *draw* and click **select**. The *draw* options are displayed along the bottom of the screen.

*Line*: This option allows you to draw straight lines.

- 1 Position the pointer on *line* and click **select**.
- 2 Position the pointer on the 'drawing board' and click and release **select** to begin the line.
- 3 Drag the line by moving the pointer to the place where you want the line to end.
- 4 Click **select** to position the line on the screen.

To stop drawing lines, choose another option or select *draw* to return to the *func* menu.

*Joined*: This option allows you to draw joined lines. You can draw straight joined lines or lines produced 'freehand'. To draw a joined line, you should:

- 1 Position the pointer on *joined* and click **select**.
- 2 Position the pointer on the 'drawing board' and click **select** to begin the line.
- 3 Drag the line by moving the pointer to the place where you want the first join to occur.
- 4 Click **select** to position the line on the screen.
- 5 To reposition the origin of your joined lines, move the pointer to the new position and click **adjust**.

To draw a line 'freehand', you should:

- 1 Position the pointer on *joined* and click **select**.
- 2 Position the pointer on the 'drawing board' and press **select**.
- 3 Keeping **select** pressed, draw the line by moving the pointer.

To stop drawing joined lines, choose another option or select *draw* to return to the *func* menu.

*Radii*: This option allows you to draw radii.

- 1 Position the pointer on *radii* and click **select**.
- 2 Position the pointer on the 'drawing board' at the point where you want the radius to begin and click **select**.
- 3 Drag the line to the point where you want the radius to end.
- 4 Click **select** to position the line on the screen.

- 5 Move the pointer to another place and click **select** again to position another radius on the screen.

You can create a 'fan' effect by keeping **select** pressed while you move the pointer around the screen.

To begin drawing radii from another position on the screen, move the pointer to your new origin and click **adjust**.

To stop drawing radii, choose another option or select *draw* to return to the *func* menu.

*Brush*: This option allows you to draw using different kinds of 'brushes'.

- 1 Position the pointer on *brush* and click **select**.
- 2 Position the pointer on the 'drawing board' at the point where you want to begin drawing.
- 3 Press **select**. Keeping **select** pressed, draw a line by moving the pointer.
- 4 Release **select** when you come to the end of the line.

*Select*: This option allows you to choose the kind of brush you wish to use with the brush option.

- 1 Position the pointer on *select* and click **select**. The *Brushes* menu is displayed on the screen.
- 2 Position the pointer on the brush you need and click **select**.
- 3 Quit the *Brushes* menu.

To paint with the brush you chose, select brush and follow the steps given in the section above: **Brush**.

To stop painting with the brush, choose another option or select *draw* to return to the func menu.

### **Shapes**

To activate *shapes* in the *func* menu, position the pointer on the box containing *shapes* and click **select**. The *shapes* options are displayed along the bottom of the screen.

*Rectangle:* This option allows you to draw rectangles.

- 1 Position the pointer on *rectangle* and click **select**.
- 2 Position the pointer on the 'drawing board' at the point you want the rectangle to begin.
- 3 Click **select**. A flashing rectangle appears when you move the mouse slightly.
- 4 Move the pointer until the rectangle is the size you require.
- 5 Click **select** to position the rectangle on the screen.

To stop making rectangles, choose another option or select *shapes* to return to the func menu.

*Square:* This option allows you to draw squares.

- 1 Position the pointer on *square* and click **select**.
- 2 Position the pointer on the 'drawing board' at the point where you want the square to begin.
- 3 Click **select**. A flashing square appears when you move the mouse slightly.
- 4 Move the pointer until the square is the size you require.
- 5 Click **select** to position the square on the screen.

To stop making squares, choose another option or select *shapes* to return to the func menu.

*Parallelo*: This option allows you to draw parallelograms.

- 1 Position the pointer on *parallelo* and click **select**.
- 2 Position the pointer on the 'drawing board' at the point where you want the parallelogram to begin.
- 3 Click **select**.
- 4 Move the pointer, dragging a line until it is the length you require.
- 5 Click **select** and move the pointer slightly. A flashing parallelogram appears.
- 6 Move the pointer until the parallelogram is the size you require.
- 7 Click **select** to position the parallelogram on the screen.

To stop making parallelograms, choose another option or select *shapes* to return to the *func* menu.

*Triangle*: This option allows you to draw triangles.

- 1 Position the pointer on *triangle* and click **select**.
- 2 Position the pointer on the 'drawing board' at the point where you want the triangle to begin.
- 3 Click **select**.
- 4 Move the pointer, dragging a line until it is the length you require.
- 5 Click **select** and move the pointer slightly. A flashing triangle appears.

- 6 Move the pointer until the triangle is the size you require.
- 7 Click **select** to position the triangle on the screen.

To stop making triangles, choose another option or select *shapes* to return to the *func* menu.

### **Curve**

To activate *curves* in the *func* menu, position the pointer on the box containing *curve* and click **select**. The curve options are displayed along the bottom of the screen.

*Circle*: This option allows you to draw circles.

- 1 Position the pointer on *circle* and click **select**.
- 2 Position the pointer on the 'drawing board' at the place which you designate to be the centre of the circle.
- 3 Click **select**. A flashing circle appears.
- 4 Move the pointer until the circle is the size you require.
- 5 Click **select** to position the circle on the screen.

To stop making circles, choose another option or select *curve* to return to the *func* menu.

*Ellipse*: This option allows you to draw ellipses.

- 1 Position the pointer on *ellipse* and click **select**.
- 2 Position the pointer on the 'drawing board' at the point where you want the ellipse to begin.
- 3 Click **select**.



- 4 Move the pointer, dragging a line until it is the length you require.
- 5 Click **select** and move the pointer slightly. A flashing ellipse appears.
- 6 Move the pointer until the ellipse is the size you require.
- 7 Click **select** to position the ellipse on the screen.

To stop making ellipses, choose another option or select *curve* to return to the *func* menu.

*Segment*: This option allows you to draw segments of circles.

- 1 Position the pointer on *segment* and click **select**.
- 2 Position the pointer on the 'drawing board' at the point where you want the segment to appear.
- 3 Click **select**.
- 4 Move the pointer, dragging a line until it is the length you require.
- 5 Click **select** and move the pointer slightly. A flashing circle appears.
- 6 Move the pointer to reduce the circle, creating a segment that is the size you require.
- 7 Click **select** to position the segment on the screen.

To stop making segments, choose another option or select *curve* to return to the *func* menu.

*Arc*: This option allows you to draw arcs.

- 1 Position the pointer on *arc* and click **select**.
- 2 Position the pointer on the 'drawing board' at the point where you want the arc to begin.
- 3 Click **select**.
- 4 Move the pointer, dragging a line until it is the length you require.
- 5 Click **select**. An arc appears.
- 6 Move the pointer until the arc is the size you require.
- 7 Click **select** to position the arc on the screen.

To stop making arcs, choose another option or select *curve* to return to the *func* menu.

*Sector*: This option allows you to draw sectors of circles.

- 1 Position the pointer on *sector* and click **select**.
- 2 Position the pointer on the 'drawing board' at the point where you want the sector to begin.
- 3 Click **select**.
- 4 Move the pointer, dragging a line until it is the length you require.
- 5 Click **select**. A flashing circle appears.
- 6 Move the pointer to reduce the circle, creating a sector that is the size you require.
- 7 Click **select** to position the sector on the screen.

To stop making sectors, choose another option or select *curve* to return to the *func* menu.

### **Text**

This option allows you to type text on the screen using the keyboard.

- 1 Position the pointer on the box containing text in the *func* menu and click **select**.
- 2 Position the pointer on the 'drawing board' where you want to begin entering text.
- 3 Click **select**.
- 4 Begin typing text.

When you come to the end of a line, move the pointer to the place you want the next line of text to begin and click **adjust**.

To stop entering text, select *text* to return to the *func* menu.

### **Area**

To activate *area* in the *func* menu, position the pointer on the box containing *area* and click **select**. The *area* options are displayed along the bottom of the screen.

*Copy*: This option allows you to copy a section of the 'drawing board' from one place to another.

- 1 Position the pointer on *copy* and click **select**.
- 2 Position the pointer on the upper right-hand corner of the section of the screen you want to copy.
- 3 Click **select** and move the pointer slightly to activate a flashing rectangle.

- 4 Move the pointer, dragging a corner of the rectangle until it frames the section you want to copy.
- 5 Click **select** to fix the size of the rectangle.
- 6 Move the rectangle to the section of the screen where you want the copy to appear.
- 7 Click **select**. The section originally framed in the rectangle is copied to the new position.
- 8 To reposition the pointer to copy another section of the screen, click **adjust** and move the pointer to the new area to be copied. Follow steps 2 to 7 above.

You can drag the section framed in the rectangle, creating a 'smeared' effect.

- 1 Follow steps 1 to 5 above.
- 2 Press **select** before you move the rectangle.
- 3 Keeping **select** pressed, drag the rectangle to another part of the screen.

To stop copying, choose another option or select *area* to return to the *func* menu.

*Move*: This option allows you to move a section of the screen from one place to another.

- 1 Position the pointer on *move* and click **select**.
- 2 Position the pointer on the upper right-hand corner of the section you want to move.
- 3 Click **select** to activate a flashing rectangle.
- 4 Move the pointer, dragging the rectangle until it frames the section you want to move.

- 5 Click **select** to fix the size of the rectangle.
- 6 Move the rectangle to the part of the screen where you want the section framed by the rectangle to appear.
- 7 Click **select**. The section originally framed in the rectangle is moved to the new position, leaving its original position empty.

To leave the *Move* function, choose another option or select *area* to return to the *func* menu.

*Clear*: This function allows you to clear the 'drawing board'.

- 1 Position the pointer on *clear* and click **select**.
- 2 Move the pointer to the 'drawing board' section of the screen.
- 3 Click **select**. The entire 'drawing board' is cleared.

To leave the *Clear* function, choose another option or select *area* to return to the *func* menu.

*Pattern*: This option allows you to use a pattern of squares in different colours rather than solid colours when drawing and painting.

- 1 Position the pointer on *pattern* and click **select**. The *Pattern* window is displayed on the screen.
- 2 Position the pointer on one of the four patterned boxes in the left-hand margin of the screen.
- 3 Click **select**. The pattern selected in step 2 will now be displayed in enlarged format in the *Pattern* window and in the box below the palette in the left-hand margin. This box is used to display the currently selected colour or pattern.

- 4 To change the pattern, position the pointer on one of the colours in the palette (the small coloured boxes at the top of the left-hand margin) and click **select**.
- 5 Position the pointer on the *Pattern* window and click **select**. The colour of the square at the pointer position will change to the colour currently selected from the palette.
- 6 Continue to build up your own pattern by repeating steps 4 and 5 above.
- 7 When you have finished creating your own pattern, quit the *Pattern* window and your new pattern will be displayed in the pattern box selected in step 2.

When you choose a brush, or use the *Fill* function, a pattern can be chosen and is treated as a colour and will appear as such on the screen.

*Fill*: This option allows you to fill in sections of the screen with a selected colour or pattern.

- 1 Position the pointer on fill and click **select**.
- 2 Position the pointer on the colour in the palette or the pattern that you wish to use for filling and click **select**.
- 3 Move the pointer to the section of the screen you want to fill in.
- 4 Click **select**. The section indicated is filled in with the currently selected colour or pattern.

### **Load and save**

To load a drawing you saved previously using Paint:

- 1 Select load from the *func* menu.
- 2 A window displaying a catalogue of the drawings previously saved from Paint will appear, eg *ARC*, the example program provided in the Welcome Suite.

- 3 Position the pointer on the file name of the drawing that you wish to load and click **select**.
- 4 The drawing will be loaded and displayed in Paint.

To save a drawing that you have created using Paint you will need to prepare a new disc, as the Welcome disc provided does not have enough room on it to allow you to save a new drawing. To prepare a new disc:

(*Note: Archimedes 400 users should ignore the information below about preparing a new floppy disc. The *Save* procedure is however the same for hard or floppy disc.*)

- 1 Format a blank floppy disc (see the chapter MANAGING DISCS for information on how to do this).
- 2 If you are not already in the desktop, restart the desktop by pressing [Ctrl][Break].
- 3 Insert your new floppy disc in the drive and click **select** on the *floppy disc* icon. A window will appear which shows a catalogue of the files and directories on your floppy disc. Initially on a blank, formatted disc, this window will be empty.
- 4 Click **menu** in the *Floppy disc* window and a *File menu* window will be displayed. (For a description of the use of the menu options, see the chapter, MANAGING DISCS.)
- 5 Click **select** on the *New dir.* option and a window will be displayed.
- 6 Enter the name of the new directory you wish to create, in this case, type APPS and click **select** on OK.
- 7 A directory icon labelled APPS will appear in the *Floppy disc* window.
- 8 Double-click **select** on directory APPS and a window displaying the content of directory APPS will appear. This will be blank initially.
- 9 Click **menu** within the APPS window and the *File menu* will be displayed.

- 10 Click **select** on the *New dir.* option and type in the name *UserPics*. Click **select** on **OK** and the new directory *UserPics* will be created as a subdirectory of directory *APPS*. It is into this *UserPics* directory that your new drawings created in Paint will be saved (see the **User Guide** chapter, **FILING SYSTEMS** for information on the structure of ADFS directories).
- 11 Quit the *APPS* and *Floppy disc* windows and remove your prepared floppy disc.
- 12 Insert your Welcome Disc into the drive and enter Paint and create your drawing as described above.
- 13 When your drawing is complete, click **select** on the save icon in the *func* menu. A window entitled *DISC SAVE* will appear.
- 14 Remove your Welcome Disc from the floppy drive, and insert the disc onto which you wish to save your drawing (as prepared above in steps 1 to 11 above).
- 15 Type in the name of the file into which you wish to save your new drawing and press [Return]. Your drawing will be saved onto your new disc into the directory *UserPics* which is a subdirectory of the directory *APPS*.
- 16 Whenever you want to save new drawings that you have created in Paint, follow steps 12 to 14 above. Remember however that whenever you wish to use Paint, you must have your Welcome Disc in the drive. Your new disc will of course eventually become full too. If this happens, create another disc to save your drawings to or delete some of your old drawings to make room for the new ones (see chapter, **MANAGING DISCS** for information on how to delete unwanted files).



### Mode

Select *mode* to choose the following options:

- *Fill* fills in shapes as you draw them.
- *Open* outlines shapes but does not fill them in as you draw them.
- *Xor*, *OR*, *AND* and *INV* allow you to blend and shade colours.

Select one of these options by positioning the pointer on the box containing the option you require and clicking **select**. Click **select** again to deselect the option you chose.

Experiment with each option using combinations of colours to see the effects they produce.

### Colours

Colours consists of a palette of colours and the colour box below the palette. They are located in the top left-hand corner of the screen.

To choose a colour, position the pointer on the box in the palette containing the colour you require and click **select**. The colour chosen is displayed in the colour box.

To change a colour on the palette, position the pointer on the word *COLOURS* and click **select**. The *Palette* window is displayed. Position the pointer on the circle or rectangle and click **select** to change the colour in the colour box.



# MANAGING DISCS

This chapter tells you how to perform various tasks essential to disc management, such as formatting a floppy disc, making a backup copy of a disc., copying files and deleting files on a disc.

Note that all floppy discs used with the Archimedes must be double-sided, double-density discs. See the chapter, TAKING CARE OF DISCS for more information on the kind of floppy discs to use with your computer.

- *Note:* for information on formatting a hard disc see the chapter, HARD DISC FORMATTING.

## HOW TO FORMAT A FLOPPY DISC

Each new floppy disc must be formatted by the computer before it can be used. Formatting divides the magnetic coating on the surface of the disc into tracks and sectors. This allows the computer to store information on the tracks in sectors so that it can be found easily. It is as if the computer creates addresses on the disc. It can later read an address, store information there and remember where to go to find the information again.

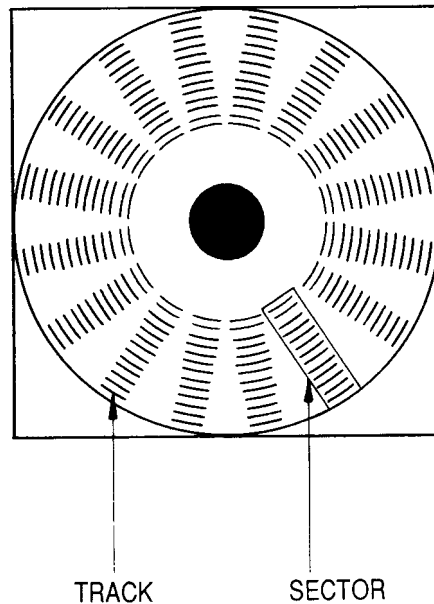

Before you format a floppy disc, note the following points:

- You can format a blank disc or reformat previously formatted discs. Note, however, that if information is already stored on a disc, reformatting it destroys that information. Be very careful about formatting any disc already containing information. Always make sure you no longer wish to keep the information, or that you have other copies of it.
- The disc you are formatting should not be write-protected. The chapter, **TAKING CARE OF DISCS** tells you how to turn write-protection on and off.
- You can format a disc to hold 640 or 800 Kbytes of information. Discs formatted to hold 640 Kbytes are compatible with the BBC Master Compact microcomputer. (See the chapter, **LEARNING MORE ABOUT THE ARCHIMEDES** for information on bytes and Kbytes.)

The steps described below tell you how to format a floppy disc to hold 800 Kbytes of information using the single floppy disc drive that comes with the machine. There are two ways to format: from the desktop or from the keyboard using the `FORMAT` command.

If you have any queries regarding using the keyboard, see the *KeyTutor* tutorial in the Welcome Suite.

### **From the desktop**

Floppy discs formatted from the desktop always hold 800 Kbytes of information. Take the following steps and begin at the Main Desktop screen:

- 1 Remove the Welcome Disc from the disc drive and insert the disc you want to format.
- 2 Position the pointer on the *disc* icon and click **menu**. A menu entitled *floppy:0* appears.
- 3 Position the pointer on the *Format* option and click **select**. The following message appears:

```
Do you really want to format drive 0?  
Yes      No
```

- 4 Position the pointer on *Yes* and click **select**. The following message appears:

```
Formatting this disc will destroy any data on it.  
OK      QUIT
```

- 5 Position the pointer on *OK* and click **select**. The computer formats the disc, taking several seconds to do so. When formatting is finished, the following message appears:

```
Formatting complete  
OK
```

If there is a fault on the floppy disc, an error message is displayed. Try to reformat the disc. If the error still occurs, the disc is probably faulty and should be destroyed.

- 6 Position the pointer on *OK* and click **select**. Formatting is complete.

#### **From the keyboard**

- 1 Remove the Welcome Disc from the disc drive and insert the floppy disc you want to format.
- 2 Quit the desktop by positioning the pointer on the *EXIT* icon and clicking **select**. An operating system prompt is displayed.
- 3 Type the following:

```
*ADFS
```

Press [Return]. The cursor drops down a line next to a new screen prompt.

4 Type the following:

```
*FORMAT 0 D
```

5 Press [Return]. The following message is displayed:

```
Are you sure (Y/N) ?
```

6 Press 'N' if you change your mind about formatting this disc. The screen prompt reappears.

Press 'Y' to format the disc. The following message is displayed:

```
Formatting xx
```

The xx begins with zero and increases until 79 is reached. When 79 appears, the following message is displayed:

```
Verifying...
```

It takes a few seconds to verify that the disc is formatted correctly. If there is a fault in the disc, an error message appears and verification stops. Try to reformat the disc. If the error still occurs, the disc is probably faulty and should be destroyed.

If no fault appears, the following message is displayed:

```
Formatted 800K
```

The screen prompt appears and format is complete.

### Formatting a 640 Kbyte disc

If you wish to format a disc to hold 640 Kbytes of information, follow the steps above with one exception. At step four type `*FORMAT 0 L`. The disc is then formatted to hold 640 Kbytes of data.

- *Note:* the 'D' stands for 'double' and is specific to the Archimedes microcomputers. The 'L' stands for 'large', and is equal to the 'large' format of the BBC Master Compact microcomputers. Use the format only if you need to use discs on both the Archimedes machine and a BBC Master Compact microcomputer.

If no errors occur during verification, the message: `Formatted 640K` is displayed before the screen prompt appears and the format is complete.

If an error occurs during the verification process, repeat the formatting steps given above. If the format is still unsuccessful, you probably have a faulty disc. The safest thing to do is to destroy it and start again with a different disc.

### HOW TO MAKE A BACKUP COPY OF A FLOPPY DISC

It is advisable to make a backup copy of the Welcome Disc (or any other disc containing important data) before you begin using it. Floppy discs can be corrupted by dust or damaged by accident. Making a backup of the disc means you always have a copy of the programs it contains.

There are several ways to make a backup copy of a disc. The explanation below assumes you are using the computer with one floppy disc drive. For more detailed information on backing up, see the chapter, **FILING SYSTEMS** in the **User guide**.

Before you begin the backup procedure, note the following points:

- You must use a formatted floppy disc.
- You can use a floppy disc already containing information. `BACKUP`, however, deletes any information contained on the disc replacing it with an exact copy of the information on the source disc.

Take the following steps:

- 1 Quit the desktop by positioning the pointer on the *EXIT* icon and clicking **select**. A screen prompt is displayed.

- 2 Type the following:

```
*ADFS
```

Press [Return]. The cursor drops down a line next to a new screen prompt.

- 3 Type the following:

```
*BACKUP 0 0
```

- *Note:* there is another way to make a backup copy of your disc which cuts down the number of times you will have to swap the source and destination discs. Type the following:

```
*BACKUP 0 0 Q
```

This option uses all available RAM and will corrupt any BASIC program in memory, but performs the backup much more quickly.

- 4 Press [Return].

The following message is displayed:

```
Are you sure (Y/N)?
```

Press 'Y' to proceed with the backup or any other key to abort.

- 5 If you press 'Y' the following message is displayed:

```
Insert source disc in drive 0 then press SPACE bar
```



- 6 Place the floppy disc containing the data to be copied into the disc drive and press the SPACE bar.

After a few moments the following message is displayed:

```
Insert destination disc in drive 0 then press SPACE bar
```

- 7 Remove the floppy disc containing the data, insert the disc onto which you wish to copy the data, and press the SPACE bar.
- 8 Repeat steps this cycle as prompted by the computer. When the backup is finished, the operating system prompt is displayed.

Keep the original Welcome Disc in a safe place and use the backup copy whenever you need the Welcome Disc programs.

### COPYING FROM A HARD DISC

With careful handling, the hard disc drive used in the Archimedes will give you reliable operation over a long period of time. In the unlikely event of a fault occurring with the hard disc drive, causing corruption of data on the disc, it may be extremely difficult to recover that data. As the data stored on your disc may represent many hours of work, it is very important to keep backup copies of your data on floppy disc. Once data is backed up onto floppy disc, these backup discs should be carefully labelled, stored and looked after as described in the chapter TAKING CARE OF DISCS. Alternatively, ask your supplier about backup systems which enable you to copy the entire contents of your hard disc onto a removable media.

- CAUTION: It is strongly recommended that you make a backup copy of the `WFORM` program (in the `Library` directory) and the Welcome Suite, onto a floppy disc when you first start to use the system.

To copy files and directories from the hard disc onto a floppy disc within the desktop, proceed *as follows*:

- 1 Format a floppy disc onto which your files will be copied and insert it into the floppy disc drive (information on formatting a floppy disc is given in the section **How to format a floppy disc** earlier in this chapter).
- 2 Click **select** on the *hard disc* icon to display a catalogue of directories and files on your hard disc.
- 3 Position the pointer on the object(s), ie directories and files, within your hard disc catalogue that you wish to copy to floppy disc and click **select**. The titles of the selected objects will change colour.
- 4 Click **select** on the floppy disc icon to display a catalogue of your floppy disc. This will be blank if you are using a newly formatted disc.
- 5 Position the pointer within the floppy disc catalogue window and click **menu**. A window labelled *File menu* will appear (more information on *File menu* is given in the section **Using the File Manager**).
- 6 Position the pointer on the Copy to option in the *File* menu and click **select**.
- 7 A message confirming the object to be copied will appear. Click **select** on *Yes* to confirm the copy or *No* to move onto next selected object.
- 8 The copy will proceed until all selected objects are dealt with.
- *Note*: if the selected object is a directory then all subdirectories and files will also be copied.
- 9 Once your floppy disc is full, and error message such as *System reported error, disc full* will be displayed. A new, blank, formatted floppy disc must now be inserted and the copy resumed following the procedure described above.

For the more experienced user, it is possible to exit the desktop and use the \*COPY command to backup files from the hard disc to a floppy disc (see the **User Guide** chapter, **FILING SYSTEMS** for information). This command gives more flexibility to the user and more information on the files being copied.

## USING THE FILE MANAGER

To allow you to perform simple disc management tasks, a file manager is provided. The file management options available to you are accessed in the desktop through the *File menu*. To access the *File menu* from the desktop:

- 1 Click **select** on the *disc* icon. A window showing a catalogue of the directories and files on the disc will be displayed.
- 2 Position the pointer somewhere in the *disc* window and click **menu**. The *File menu* will be displayed.

You will notice that some of the options in *File menu* appear in bolder text than others. The options in bold text can be selected and used by positioning the pointer on them and clicking select. The faint options in the *File menu* require you to select one of the objects in the disc catalogue before you can use them. Once you have selected an object, ie positioned the pointer on one of the icons in the disc catalogue and clicked select, then you will see that all the options in *File menu* are in bold text and hence available to you.

### Creating a new directory

To create a new directory on your disc, take the following steps:

- 1 Move to the directory on your disc where you wish the new directory to be created. Remember that you can have a directory as a subdirectory of another ( see the **User Guide** chapter, **FILING SYSTEMS** for information on the structure of ADFS directories).
- 2 Position the pointer within the catalogue window of the directory in which the new directory is to be created and click **menu**. The *File menu* will be displayed.

- 3 Position the pointer on the *New dir.* option in the *File menu* and click **select**. A window will appear into which you should type the name of your new directory.
- 4 Type the directory name and click **select** on OK.
- 5 A new, empty directory with the name that you have chosen, will be added to the catalogue. Note that the catalogue entries are displayed in alphabetical order by name.

### **Copying files and directories**

To copy a file or directory within the same directory on a single disc, take the following steps:

- 1 Display the catalogue window which contains the object (directory or file) that you wish to copy.
  - 2 Click **select** on the object or objects that you wish to copy.
  - 3 Click menu and the *File menu* will appear.
  - 4 Click **select** on the *Copy to* option and a window will appear giving you the option to rename your object on copying.
  - 5 Type in the new object name and click **select** on OK.
  - 6 The object will be copied into the current directory with the new name.
  - 7 If you selected more than one object to copy then repeat steps 5 and 6 above until all your selected objects are copied.
- *Note:* if the object to be copied is a directory, then all subdirectories and files are also copied.

To copy on object to another directory:

- 1 Display the catalogue window which contains the object(s) to be copied.

- 2 Click **select** on the object(s) to be copied.
  - 3 Move to the directory into which you wish to copy the object(s) and in this directory click menu to display the *File menu*.
  - 4 Click **select** on the *Copy to* option in the *File menu* and window will appear confirming the copy.
- *Note:* when you are copying between directories, you do not have the option to rename the object.
- 5 To copy the object click **select** on *Yes*.
  - 6 The object will be copied to the new directory and displayed in the catalogue.
  - 7 If more than one object was selected to be copied, repeat step 5 above until all selected objects are copied.

### **Moving files and directories**

If you wish to move an object from one directory to another, ie remove it from one directory and place it in another then take the following steps:

- 1 Display the directory catalogue window which contains the object(s) to be moved.
- 2 Click **select** on the object(s) to be moved.
- 3 Move to the destination directory of the objects and in the destination directory click **menu** to display the *File menu*.
- 4 Click **select** on the *Move to* option in the *File menu* and a window will appear confirming the move.
- 5 Click **select** on *Yes* and the object(s) will be moved.

- *Note:* if the object to be moved is a directory, then all subdirectories and files will also be moved.

### **Deleting files and directories**

To delete unwanted files and directories from your disc, take the following steps:

- 1 Display the catalogue window of the directory which contains the object(s) to be deleted.
- 2 Click **select** on the object(s) to be deleted.
- 3 Click **menu** to display the *File menu*.
- 4 Click **select** on the *Delete* option and a window will appear confirming the deletion.
- 5 If you wish to continue and delete the file, click **select** on *Yes* and the object(s) will be deleted from your disc.

- *Note:* if the object to be deleted is a directory, then all subdirectories and files will also be deleted.

### **Renaming files and directories**

To rename a file or directory, take the following steps:

- 1 Display the catalogue window for the directory which contains the object(s) to be renamed.
- 2 Click **select** on the object(s) to be renamed.
- 3 Click **menu** to display the *File menu*.
- 4 Click **select** on the *Rename* option in the *File menu* and a window will appear giving you the option to enter the new name for your selected object.

- 5 Type in the new name and click **select** on OK.
- 6 The object(s) will be renamed and displayed in the catalogue.

### Changing from Icons to Names

It is possible, using the *File menu* to display information on the contents of your disc directories in terms of words and numbers rather than icons. To do this, take the following steps:

- 1 Move to the directory in which you wish the display to be changed.
- 2 Click **select** on **menu** to display the *File menu*.
- 3 Click **select** on *Names* in the *File menu* and the catalogue will be displayed as names rather than icons.
- 4 To change back to icons, click select on *Icons* in the *File menu*.

The information displayed when you select *Names* contains the following details:

name of object  
 attributes  
 object type  
 time and date stamp or load and execute address (in hexadecimal)  
 length in bytes (in decimal)

For example:

Fonts	DL directory	11:35:45 10-Sep-1987	2048
GameCode	WR file	00008000 0000A614	39440
Lander	file_basic	14:10:31 16-Oct-1987	153

It is not important initially that you understand the information displayed when you select *Names*. If you want to find out more then refer to the **User Guide** chapter, **FILING SYSTEMS** for details.





The Archimedes comes ready for use with a parallel printer. If, however, you are using a serial printer, or if you have set the computer for use with a serial printer and then wish to reset it for use with a parallel printer, you need to take the steps outlined below.

Configuring for printers means you tell the computer that you want it to recognise any changes you have made to the printer settings whenever the machine is turned on. This avoids having to follow the reset procedure every time you turn the computer off and on again.

If you are uncertain whether your printer is parallel or serial, see the manual accompanying the printer or consult your supplier. Further information on serial and parallel printers is given in the chapter PRINTERS in the **User Guide**.

## PRINTER SETTINGS

To set the computer for use temporarily with a serial printer, take the following steps:

- 1 Move the pointer to the quit icon. Click **select** to quit the desktop. The operating system prompt is displayed.
- 2 Type the following:  
  
\*FX 5,2
- 3 Press [Return].

If you follow the above procedure and your serial printer does not work with the Archimedes, you may need to set serial parameters. Information on these parameters and how to set them is given in the chapter PRINTERS in the **User Guide**.

To set the computer for use with a parallel printer, at step 2 type \*FX 5,1 and press [Return]

## CONFIGURING PRINTER SETTINGS

To configure serial printer settings so that every time you turn the computer on it recognises a serial printer is attached, type

```
*CONFIGURE PRINT 2 [Return]
```

[Ctrl][Break]

To configure parallel printer settings so that every time you turn the computer on it recognises that a parallel printer is attached, type

```
*CONFIGURE PRINT 1 [Return]
```

[Ctrl][Break]

The printer configuration remains until you change it using another \*CONFIGURE command.

\*FX 5 n (where 'n' is printer type 1 or 2) can be used to change the setting temporarily. Network users should use printer type 4 instead of 1 or 2.

This chapter tells you how to care for and clean your computer, how to remove the top cover, and how to change the internal batteries.

## HOW TO CARE FOR THE ARCHIMEDES

The Archimedes is solidly constructed and should prove very reliable and safe. You cannot damage it by pressing a key in the wrong way or clicking the mouse in the wrong place. However, as with any machine, the best performance is achieved if some basic cautions are observed:

- Keep the machine within a room temperature of 5 to 35 degrees Celsius (41 to 95 degrees Fahrenheit) and a relative humidity of 15% to 95% (non-condensing).
- Avoid sudden extremes in temperature, exposure to direct sunlight, heat sources (for example, an electric fan heater) and rain.
- Give the computer enough space for air to circulate on all sides. Don't cram it into a small space while in use.
- If the Archimedes is to be moved, always transport it in its original packaging and take care not to subject it to undue bumping and jarring.
- Don't spill liquids on the computer. If liquid does spill on it, turn it off immediately and take it to your supplier for assessment.
- Don't drop the mouse, keyboard, monitor or computer unit.
- Don't let the keyboard or mouse hang by its cable.
- Don't poke objects through the ventilation openings in the computer casing, and don't let items such as necklaces, bracelets or paper clips drop into the openings.

## HOW TO CLEAN THE COMPUTER, MONITOR AND KEYBOARD

Note the following points as regards cleaning the computer:

- A soft, slightly damp cloth may be used to clean the casings. Rub them gently.
- A glass cleaner may be used on the screen. Never spray the cleaner directly on it. Spray a small amount onto a soft, clean cloth and wipe the screen gently with the cloth.
- Never let liquid run down between the keys on the keyboard, or any other part of the computer.

## HOW TO CLEAN THE MOUSE

The mouse should be used on a surface that is clean and as dust-free as possible. Dust, however, does sometimes get caught up in the ball on the underside of the mouse.

Give the mouse an occasional cleaning to keep it running smoothly. To do so, you need the following items:

- a standard cross-head (e.g. Philips) screwdriver
- alcohol or tape head cleaner
- a cotton swab
- a lint-free, dry cloth.

To remove the ball and clean the mouse, take the following steps:

- 1 Unplug the mouse and turn it upside down.

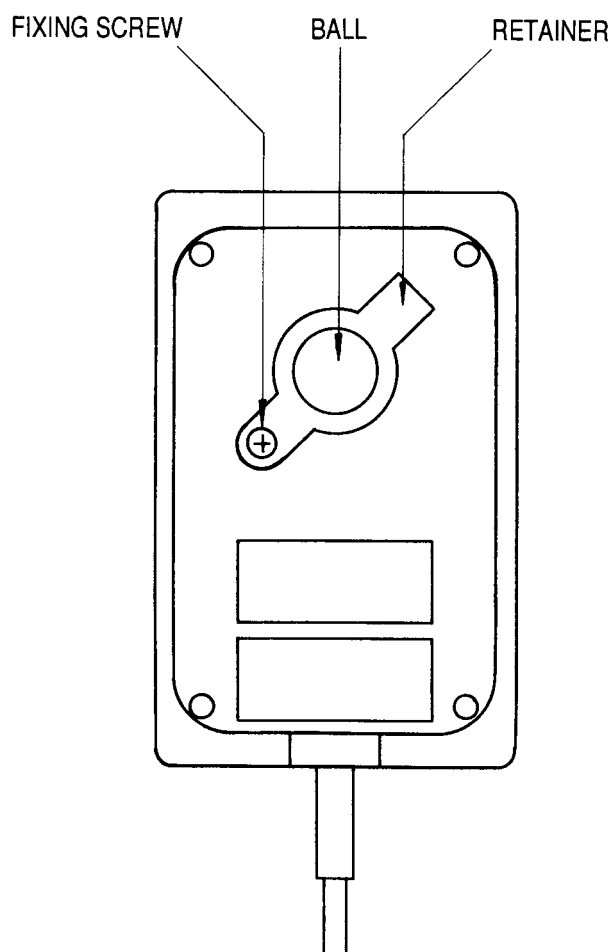

- 2 Using the cross-head screwdriver, remove the screw holding the retainer.

- 3 Hold one hand over the ball and retainer and turn the mouse right side up, allowing the ball, screw and retainer to drop into your hand. Set them aside in a safe place.

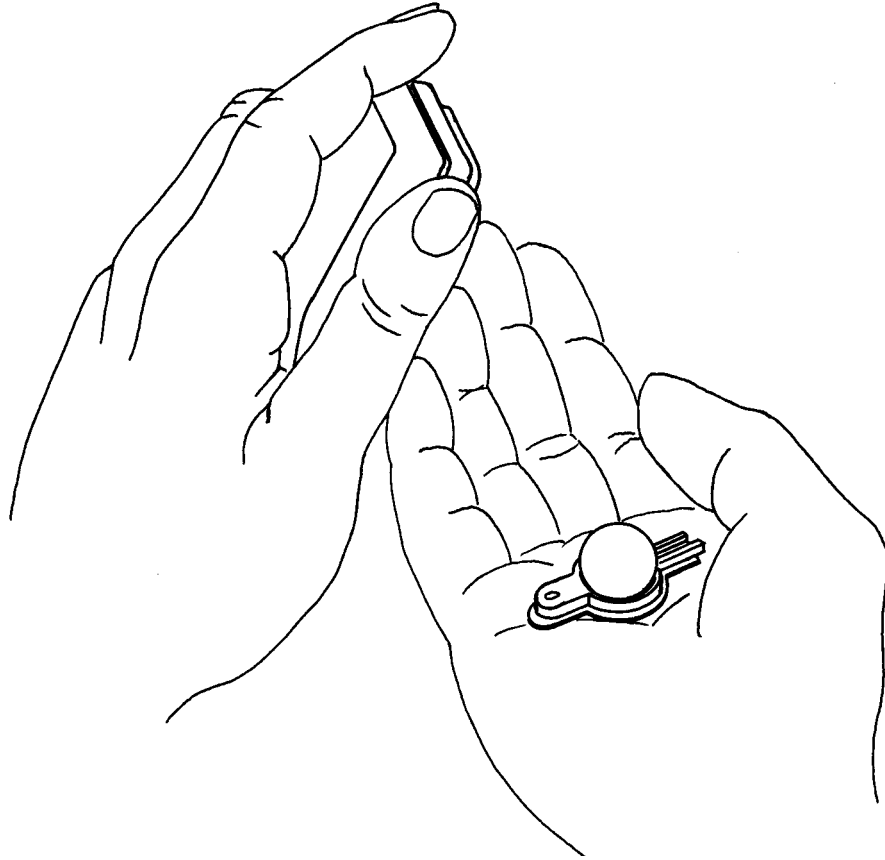

- 4 Locate the three plastic rollers as shown in the drawing.

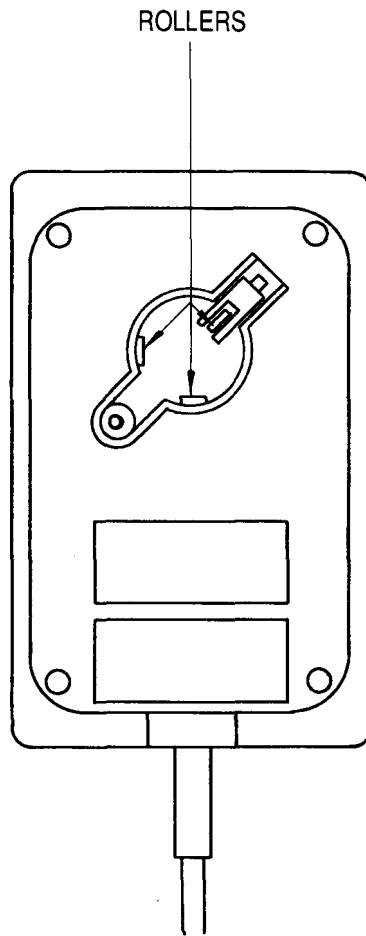

- 5 Lightly moisten the cotton swab with alcohol or tape head cleaner and apply it gently to the rollers. Rotate the rollers, carefully cleaning off any dust or dirt that may be clinging to them.

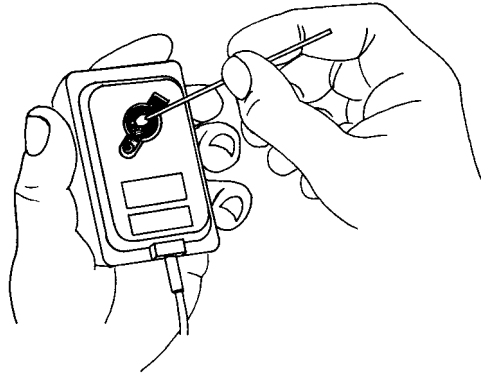

- 6 Make sure the inside of the mouse is free from dust.
- 7 Rub the ball on the clean, dry cloth. Do not use a cloth which may leave lint, and do not use cleaning liquid on the ball.

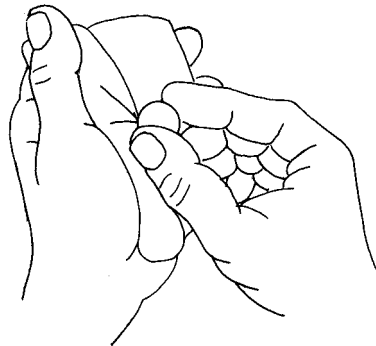



To replace the ball and retainer, take the following steps:

- 1 Turn the mouse upside down and place the ball back in the case.
- 2 Return the retainer to its original position with the square end pointing towards you and the round end pointing away from you.
- 3 Replace and tighten the screw.

## HOW TO CHANGE THE INTERNAL BATTERIES

Inside the computer are two standard AA (LR6 or HP7) size alkaline batteries which power part of the computer's internal memory (memory *is* discussed in the chapter, **LEARNING MORE ABOUT THE ARCHIMEDES**). It is in this part of battery-powered memory that the computer's clock and calendar (as well as the configuration status of the machine) are stored, making it possible for the clock and calendar to continue keeping the date and time even when the computer is turned off.

- *Note:* 'Configuration' is a general term given to the assembly of a computer system. 'Configuration status' relates to the state of configuration recognised by the computer at start-up. For example, the Archimedes comes configured for use with one floppy disc drive and a parallel printer (the configuration status).

If you have changed the configuration status of the machine, you may need to make a note of the changes so that you can easily reset them after new batteries are installed.

See the User Guide if you require information on the configuration status of the machine.

Approximately once a year the batteries require changing. You need to remove them and install two standard AA (LR6 or HP7) long-life, high-capacity alkaline batteries (for example Duracell MN 1500).

Do not use batteries with non-leakproof cells. If they deteriorate, the chemical reaction spoils the inside of the computer.

The battery nest is located inside the computer unit, necessitating the removal of the computer's top cover. Before you begin, have the following items at hand:

- a standard cross-head (e.g. Philips) screwdriver
- two standard AA-size alkaline batteries.

Take the following steps to change the battery. Be careful not to disturb the parts inside the computer:

- 1 Turn the computer off and unplug it.
  - 2 Position the computer so that you have easy access to the back of the machine.
  - 3 Locate the three screws at the top of the back panel and remove them.
- *Note:* the back panel of the Archimedes 400 series will be different to that shown on the diagram below. The three screws are, however, in the same place.

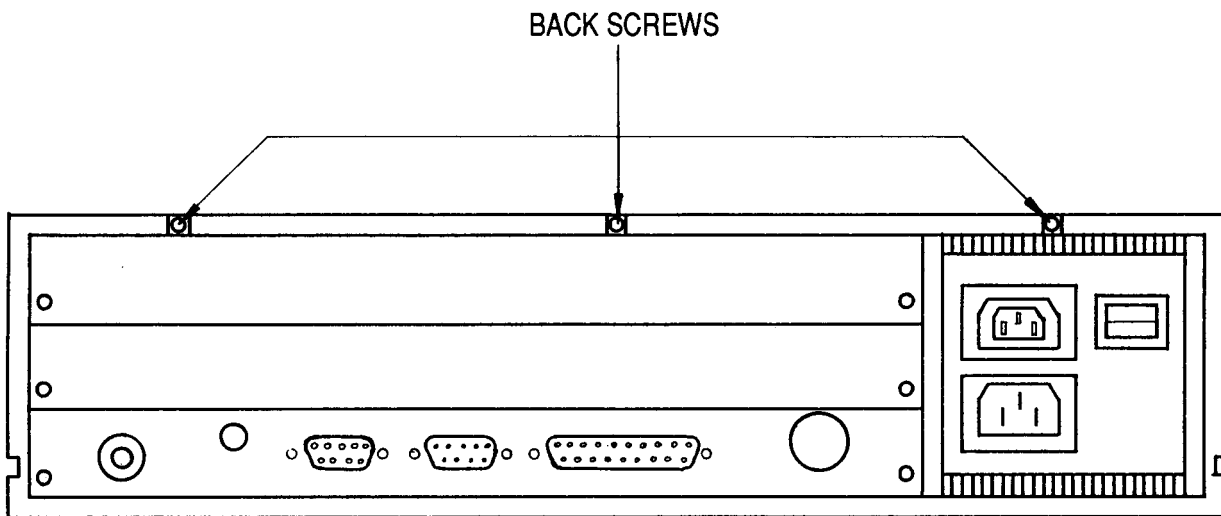

- 4 Locate the screws on either side of the computer as shown in the drawing below (there is one screw on each side):

**Side view**

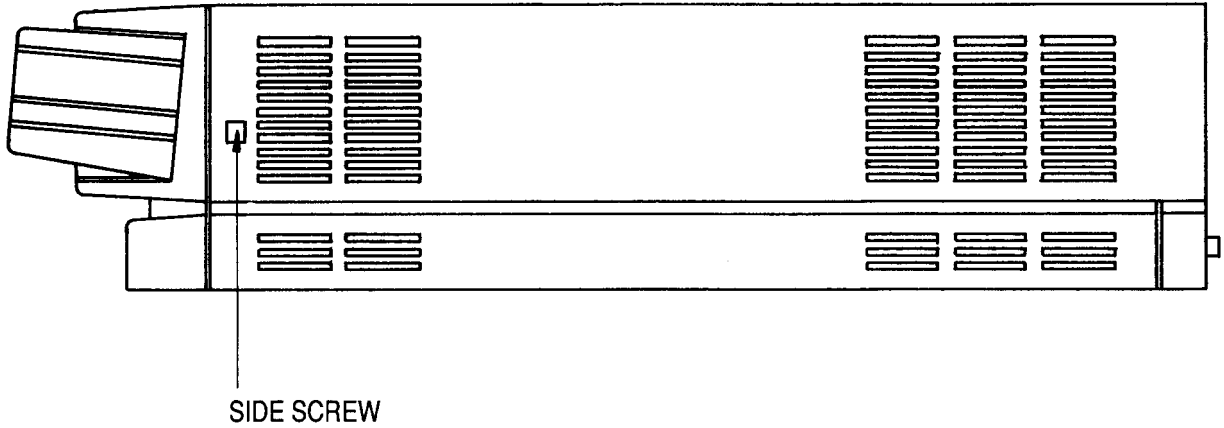

- 5 Unscrew and remove each screw.
- 6 Face the back of the machine and grasp each side of the computer's top cover. Pull carefully, sliding the cover until the front half of the inside of the computer is exposed. Do not remove the cover all the way.

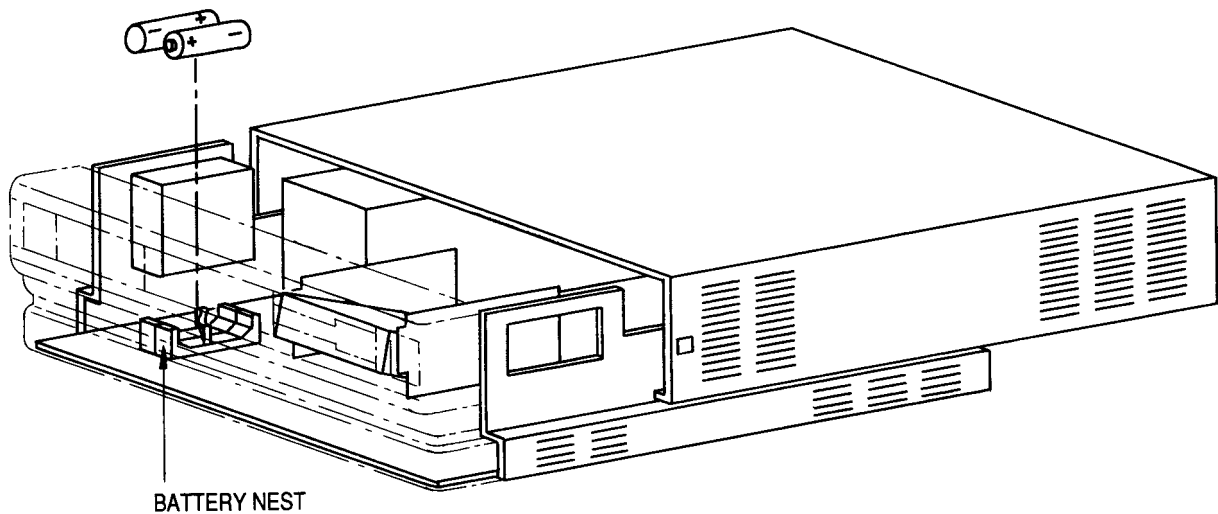

- 7 Locate the battery nest. It is in the front right-hand corner of the computer as you face the machine from the back. Remove the worn out batteries and dispose of them. You cannot remove the battery nest itself. Take care not to unplug the flying lead attaching the battery nest to the printed circuit board.
- 8 Insert the new batteries as shown in the drawing above, making sure the positive and negative ends are the right way around.

**WARNING:** It is possible to insert the batteries the wrong way around. Make sure you insert them correctly.

- 9 Return the top cover to its original position and replace the screws. Reconnect the computer to a mains outlet. Press **R**. Keeping **R** pressed, turn the machine on at the power-on switch. This resets the configuration status of the computer to its original factory settings. If, however, your monitor does not display a picture correctly, repeat this procedure.

- *Note:* the reset procedure outlined above toggles between the state for a standard monitor and that for a high-resolution monitor. It is for this reason that you might reset the computer for the wrong monitor. Repeat the procedure to activate the correct state.

If the configuration status you require *is* not the same as the factory setting, reconfigure the computer to your preferred status.

### HOW TO CHANGE THE FAN FILTER WHEN FITTED

The computer's fan filter needs changing approximately once a year. It is a good idea to change the filter while changing the batteries. A new filter can be purchased from your dealer.

- *Note:* the fan filter is optional to the Archimedes 300 series but is fitted as standard to the Archimedes 400 series.

The drawing below shows where the fan, nuts and filter are located.

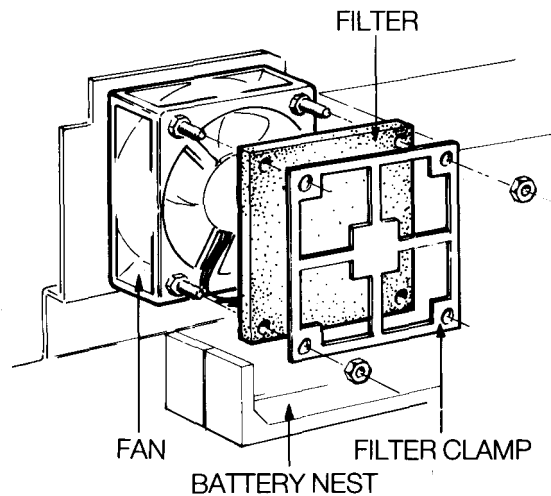

To change the filter, take the following steps (be careful not to disturb the parts inside the computer):

- 1 Make sure the computer is turned off and the mains lead disconnected.
- 2 Remove the computer's top cover as described in steps 1 to 6 in the section, **How to change the internal batteries.**
- 3 Locate the fan. It is in the front right-hand corner of the computer next to the battery nest as you face the machine from the back.
- 4 Undo the two M4 nuts retaining the filter clamp.
- 5 Remove the filter clamp and filter and replace the filter with a new one.
- 6 Return the filter clamp to its original position. Make sure the nuts are replaced in the right positions and securely tightened.

# TAKING CARE OF DISCS

This chapter discusses the following:

- the parts of a 3 1/2 inch floppy disc
- how to care for floppy discs
- how to insert and remove them from the floppy disc drive
- how to write-protect floppy discs
- how to label floppy discs
- how to care for hard discs.

## FLOPPY DISCS

Floppy discs, like magnetic tapes or gramophone records, are used for storing information. You have already used the Welcome Suite and are familiar with the information stored on it (see the chapters, **LEARNING MORE ABOUT THE ARCHIMEDES** and **USING THE DESKTOP AND WELCOME SUITES** if you have any questions). The information here describes how to the care for all 3 1/2 inch floppy discs, including the Welcome Disc.

The floppy disc drive in your Archimedes is known as a 'double-sided, double-density' drive. Drives of this type are often referred to as `DSDD`.

To achieve the best possible use from discs, only purchase discs of good quality which are meant for a double-sided, double-density drive: do not use single-sided or single-density discs.

## THE PARTS OF A FLOPPY DISC

A floppy disc is a small, flexible (floppy) plastic disc. It is coated with magnetic material and encased in a sturdy jacket. The drawing below shows the front and back of a 3 1/2 inch disc.

Note that it has a plastic jacket, a metal protective covering over the head window, a write-protect tab, and a floppy disc label.

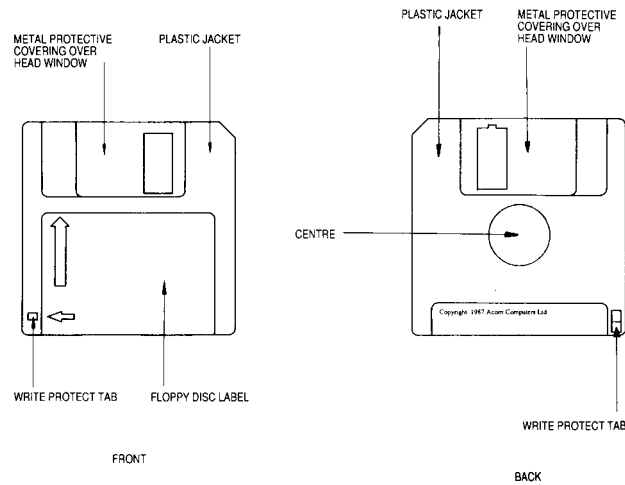

During use the disc spins inside the jacket. The metal protective covering moves aside and the disc drive's read/write head accesses the magnetic surface of the floppy disc through the head window.

- *Note:* a read/write head is similar to the record/playback head on a cassette recorder. It is used to 'write' information on a floppy disc and/or 'read' information from a disc.

## CARE OF FLOPPY DISCS

Floppy discs are very important to your computer system. Since they are sensitive, they are enclosed in a plastic casing for protection. Nevertheless, they should be handled with care. If one becomes damaged you may lose valuable information. A few precautions will ensure your data *is* not lost:

- Store discs in the container they came in, or purchase a disc storage box specifically designed to hold 3½ inch floppy discs.
- Do not attempt to clean the surface of a disc. Cleaning fluid can prevent the disc drive from properly reading the information stored on the disc.



- Do not attempt to take the disc apart, or move the metal protective cover to expose the head window.
- Protect the head window from fingerprints and the disc from dust and smoke.
- Do not write on the disc with a pencil. Pencil lead is like dust to the read/write head in the floppy disc drive.
- Keep discs away from direct sunlight and extreme heat or cold.
- Do not *use* an eraser on the disc label or near a disc.
- Keep discs away from magnetic sources such as permanent magnets, transformers, loudspeakers, hi-fi equipment and televisions.
- Never remove a disc from the computer or turn the computer off when the disc in-use light is on. This light indicates that the computer is accessing or retrieving data from the disc, and to remove the disc while the light is on may cause information to be lost.

We recommend that you use floppy discs made by a leading manufacturer. Cheap discs can be unreliable, causing loss of data and possible damage to the disc drive.

## INSERTING AND REMOVING FLOPPY DISCS

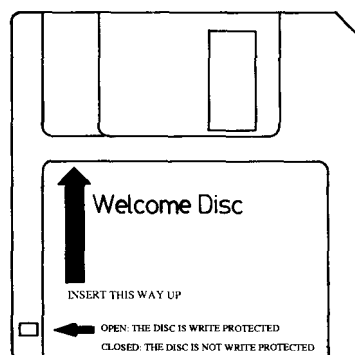

The drawing above shows you the correct way to insert a floppy disc into the drive. The disc enters the drive in the direction the arrow is pointing. Follow these steps:

- 1 Hold the disc with the insert-arrow side up. Your fingers should be holding the label with the metal protective cover pointing away from you.
- 2 Insert the disc into the disc insertion slot.
- 3 Gently push until the disc clicks into place and the disc eject button pops out. Do not force the disc into the drive.

If you insert the disc upside down or back to front, it does not completely enter the disc drive, but keeps popping out. Do not attempt to force a disc into or out of the drive. If it does not go in easily, take it out and check that you are inserting it properly.

Remove the disc by pressing the disc eject button. The disc pops part-way out for easy removal by hand. If it does not come out easily, have it removed by a trained repair person. Store it in a disc storage box.

## WRITE-PROTECTING FLOPPY DISCS

Microcomputers often provide safeguards to make sure you do not accidentally delete data. One of these safeguards is the ability to 'write-protect' floppy discs. When a disc is write-protected, you cannot delete data from it or add data to it. Only discs that are not write-protected can be changed.

– Note: if you let a disc get near a magnetic device, data on the disc can be altered or the disc damaged even though write-protect is on.

A faulty disc mechanism inside a computer can also damage a disc even though write-protect is on.

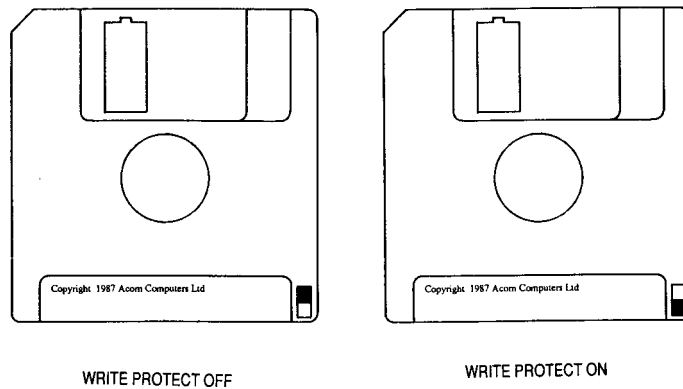

Write-protect a floppy disc by sliding the write-protect tab to uncover the small hole. When this hole is exposed, the computer cannot alter information on the disc.

To remove write-protection, slide the tab to cover up the hole.

The drawing above shows the position of the write-protect tab both when write-protect is on and when it is off.

## LABELLING FLOPPY DISCS

If you are using floppy discs other than the Welcome Disc that came with the Archimedes, you need to label them to help you keep a record of the data they contain.

Floppy discs produced by leading manufacturers usually come with stick-on labels in a choice of colours for your convenience. When labelling discs, only use labels specifically designed for use on discs and never write on a disc label with a pencil (dust from pencil lead can get under the plastic casing and damage a disc).

## CARE OF HARD DISCS

A 20 Megabyte hard disc is installed as standard in an Archimedes 440 and can be fitted as an optional upgrade to other computers in the Archimedes range. (See your supplier for details of fitting a hard disc.) The hard disc is used in a similar way to a floppy disc for data storage, except that the hard disc is permanently 'present' once the computer is switched on (compared to floppy disc which is removeable).

The hard disc unit is a delicate mechanism and needs to be handled carefully. The following points should be noted when using your hard disc:

- When the hard disc is in use, the read/write heads are positioned very close to the magnetic media coating the disc. If the drive is moved during use it is possible that damage could be done to the magnetic media, causing corruption of data on the disc.
- It is recommended that you always 'park' the hard disc drive heads before you switch the computer off. 'Parking' the heads means that they are moved to a special part of the disc surface where there is no data stored and hence where contact between the stationary heads and the disc media will do no harm. To 'park' the drive heads from the desktop, proceed as follows:

- 1 Click **menu** on the *hard disc* icon in the desktop. A window containing the word *bye* will appear.
- 2 Click **select** on the word *bye* and the disc heads will be parked.

To 'park' the drive heads outside the desktop proceed as follows:

- 1 Type \*ADFS [Return]
- 2 Type \*BYE [Return]

- If the Archimedes is to be moved from one location to another, always park the drive heads before switch off (as described above) and always transport the computer in its original packaging and take care not to subject the computer to undue bumping or jarring.
- Make regular backup copies of important data on your hard disc onto floppy disc. Once you have made backups of data onto floppy discs, then carefully label and store the floppy discs as described earlier in this chapter. Information on how to copy files from your hard disc to floppy disc is given in the chapter, MANAGING DISCS.
- It is possible for hard discs to develop defects during normal use. A defect is a very small area of the hard disc surface which is no longer able to store data reliably. This type of defect is not unusual in hard disc systems and is not normally symptomatic of a failure in the equipment.

It is important that the Advanced Disc Filing System (ADFS) which organises where data is stored on the disc, is 'told' where these defects are located in order that it can avoid using these areas for future data storage. Such defects will normally make themselves known to you in the form of 'Disc errors' during normal use of the hard disc.

There is currently only one way of informing the ADFS of the location of these defects and this requires that the hard disc be reformatted. During the verification process that always follows reformatting, all disc surfaces are checked for their ability to store data accurately. If any areas are found to be unreliable, then the locations of these areas are added to a 'map' of defects which is then stored on the hard disc itself. The ADFS can then consult this 'map' to determine where the defects on the hard disc are located and hence where not to store data.

For information on how to reformat your hard disc see the chapter, **HARD DISC FORMATTING**. Remember that reformatting the disc will destroy the data stored on it and hence all data which you want to keep should first be copied from the hard disc to a floppy disc.

# USING THE KEYBOARD

The Archimedes keyboard is shown in the drawing below. It has many of the keys a typewriter has, plus some keys specific to computers.

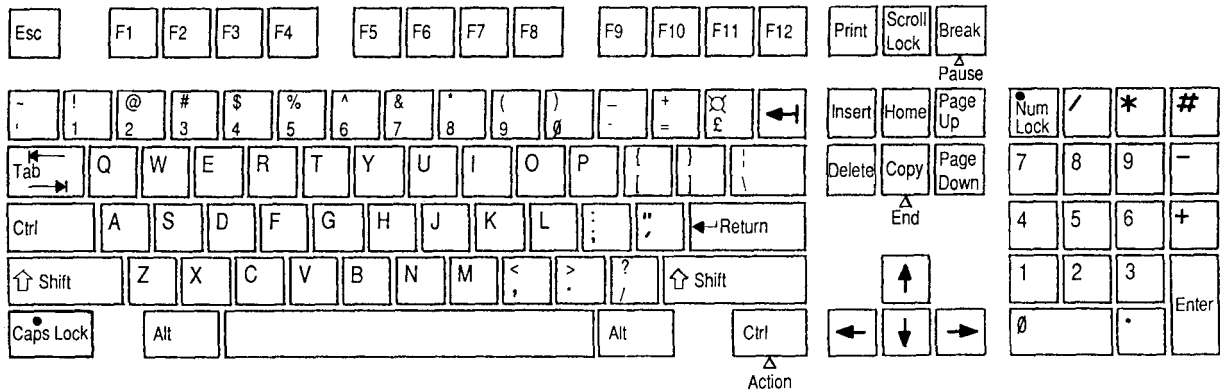

The keys are 'auto-repeat', that is, they repeat when pressed and held.

The tasks keys perform may vary depending on the software or other application you are using. This discussion tells you how the keys are used with BASIC and the operating system. If you are using a different application, the keys may not always perform as described here. If you have any queries, see the instructions accompanying the application.

The keyboard can be divided into four sections:

- typewriter keys
- computer/keyboard control keys
- function keys
- numeric keypad keys.

Each section in turn is described below.

## TYPEWRITER KEYS

The typewriter keys are the keys in the centre of the keyboard. When pressed, they produce characters and symbols which appear on the screen just as pressing a key on a typewriter produces a character or symbol on a page.

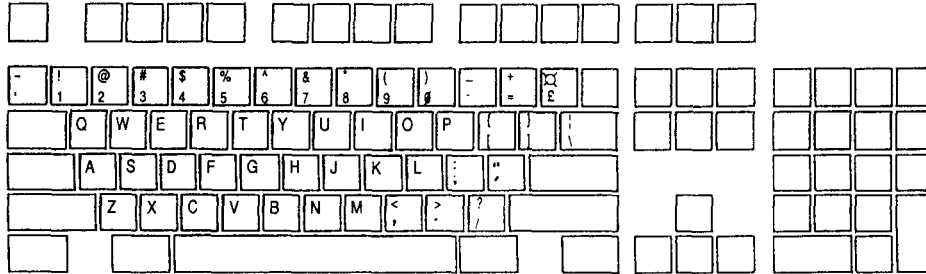

There are, however, a few differences between these keys as they are used on a typewriter and as they are used on the computer:

### The Space Bar

The Space Bar does not just create a blank space as it does on a typewriter. When you press the Space Bar, all you see on the screen is the movement of the cursor, but the computer recognises the space as it would a character and treats it in the same way.

Lower-case 'l' (l) and one (1)

The lower-case 'l' and the number one are not interchangeable as they are on a typewriter.

### Upper-case 'O' (O) and zero (0)

The upper-case 'O' and the zero are not interchangeable as they are on a typewriter.



## COMPUTER/KEYBOARD CONTROL KEYS

The computer/keyboard control keys are the dark keys on the keyboard. They perform computer-specific tasks.

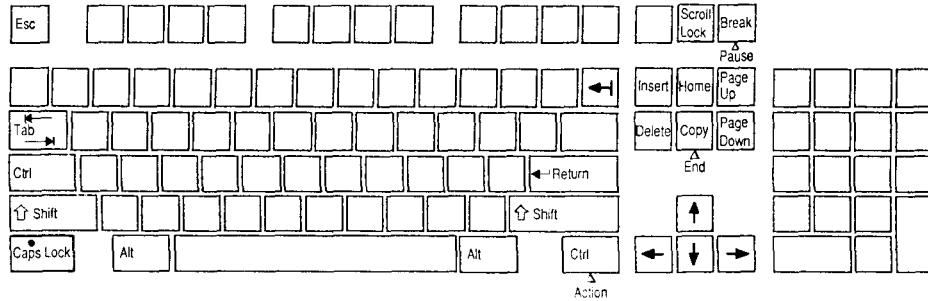

**Esc**

This cancels an operation or terminates the running of a BASIC program.

**Tab**

This key is similar to the tab key on a typewriter. It moves the cursor forward.

**Ctrl**

(There are two [Ctrl] keys, one on either side of the keyboard.) [Ctrl]

[Ctrl] generates ConTRoL characters which control various aspects of the machine. It is always used in conjunction with another key. Hold it down while pressing the key or keys required. For example, pressing [Ctrl]L causes the screen to clear. See the **User Guide** for an explanation of control characters.

**Shift**

(There are two [Shift] keys, one on either side of the keyboard.)

Press [Shift] to obtain the upper-case of the alpha (A to Z) keys and the upper symbol of keys containing two symbols.

Some applications use [Shift] plus one of the keys labelled F1 to F12 at the top of the keyboard to perform certain

tasks. The tasks assigned depend on the application you are using.

**Caps Lock**

This is a toggle key. When pressed, a light on the key comes on showing [Caps Lock] is engaged. It remains engaged (with the light on) until pressed again.

When [Caps Lock] is on, then a key containing an alpha character produces an upper-case letter.

When [Caps Lock] is on, then a key containing two symbols produces the lower symbol on the keytop.

**Alt**

This key is used in conjunction with another key to make characters not found on the keyboard available. See the **User Guide** for examples of its use.

**Scroll Lock**

Pressing [Scroll Lock] stops the screen display from scrolling out of sight. It is a toggle key: pressing [Scroll Lock] again restarts screen display.

Note that holding down [Ctrl][Shift] produces the same effect as [Scroll Lock] . However, releasing [Shift] causes the screen to scroll more slowly than normal.

**Break**

Pressing [Break] on its own cancels an operation or stops a BASIC program.

Pressing [Shift][Break] performs an automatic start-up ( auto-boot). You must hold down [Shift] and press and release [Break].

**←**

Pressing [Ctrl][Break] is like pressing the reset button.

This is the backspace key. It is similar to a backspace key on a typewriter. Pressing [Back] moves the cursor one character to the left.

**↵**

This is the 'return' key. It is similar to the carriage return on a typewriter, signalling the end of a line. Pressing [Return] advances one line and moves the cursor back to the left-hand side of the screen.

If you enter a command (for example \*CAT), pressing [Return] tells the computer to carry out the command.

**Insert**

This key is application-specific. The task(s) it performs depend on the software you are using.

**Home**

Pressing [Home] causes the cursor to move to the top left-hand corner of the screen.

**Page Up** **Page Down**

These keys are not used by BASIC or the operating system (see the chapter, LEARNING MORE ABOUT THE ARCHIMEDES for information on the operating system). The tasks they perform depend on the software you are using.

**Delete**

When [Delete] is pressed, the character to the left of the cursor is deleted. At the same time the cursor moves one character space to the left.

← → ↑ ↓

These are the cursor movement keys; they are also called arrow keys. When pressed they move the cursor in the direction indicated by the arrow on the keytop.

**Copy**

This key copies characters on one line to another line (called the input line). To use [Copy], position the cursor under the characters to be copied using the arrow keys, then press [Copy]. The line being copied appears on the input line.

**Pause** **End** **Action**

These legends are printed on the front of three keys as follows:

[Break]                      [Pause]

[Copy]                         [End]

right [Ctrl]                 [Action]

They are not used by BASIC or the operating system. (See LEARNING MORE ABOUT THE ARCHIMEDES for information on the operating system.) The tasks they perform depend on the application you are using.

## FUNCTION KEYS

The function keys are the keys at the top of the keyboard labelled F1 to F12 and [Print].

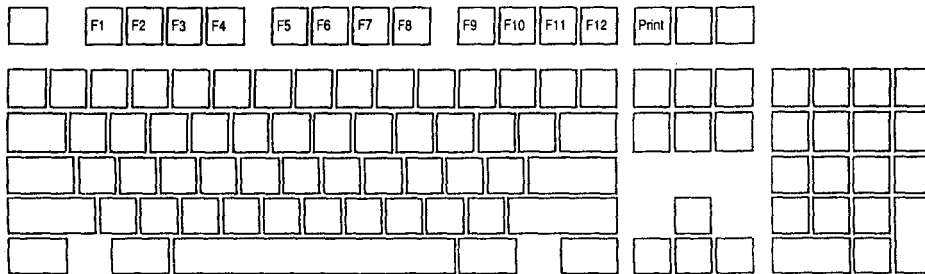

These keys do not have specific functions in BASIC. They can be assigned functions by the operating system command, \*KEY. For example, typing

```
*KEY 3 FRED [Return]
```

makes FRED appear on the screen when [F3] is pressed.

[Print] acts as if it is a function key labelled F0 (for BBC Master Compact microcomputer compatibility). It can also be assigned different tasks depending on the application you are using.

## NUMERIC KEYPAD KEYS

The numeric keypad keys produce numbers when pressed just like the keys 0 to 9 on the main keyboard. They are grouped together as a 'keypad' for convenience.

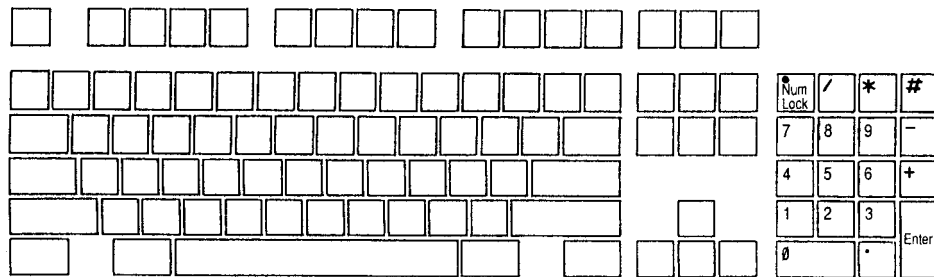

Note the following points:

- [Enter] is normally identical to [Return] on the main keyboard.
- [Num Lock] is a toggle key. When pressed, a light comes on showing it is engaged. It remains engaged (with the light on) until it is pressed again. The effect it has on the numeric keypad depends on the application you are using.

Try the *KeyTutor* tutorial in the Welcome Suite for 'hands-on' experience with the keyboard.



# LEARNING MORE ABOUT THE ARCHIMEDES

The aim of this chapter is to help you understand what is happening inside the computer. It is not intended to be a detailed discussion of computer science. If you understand why a computer functions as it does, you can use the machine more effectively.

The chapter includes:

- what every computer does best
- a definition of hardware and software
- how most microcomputers process data
- the operating system that supervises activity in the Archimedes
- how the computer organises information using the Advanced Disc Filing System (ADFS)

## WHAT THE COMPUTER DOES

Every task a computer performs, such as word processing, graphics or sound reproduction, is a combination of 'mathematical' operations (addition, subtraction, multiplication and division), logical operations, comparisons (equal to, less than and greater than) and data transfer operations.

Whether the computer is calculating figures you have entered on a spreadsheet, drawing a diagram from instructions you have given it or carrying out any other computer function, it must use one or more of these operations. It is the ingenuity of the programmers and the sophistication of the hardware which enable the computer, using these operations, to perform the tasks required.

### **Computer programs**

Computers are used to implement solutions to problems. They do not think, act on intuition or make unplanned decisions. Every activity a computer carries out must be controlled by a program.

A program is a list of short instructions. The computer follows the instructions using the operations mentioned above.

Below is an example of a program, written in English (rather than in a programming language used by programmers) to give you an idea of how a program works. It tells the computer to display all the numbers from zero to nine on the screen:

- 1 Start.
- 2 Put the number 0 where it can be found again. Call this place 'A'.
- 3 Get the number in A and display it on the screen.
- 4 Look at the number in A. If it is equal to 9, go and do instruction 7. If it is not equal to 9, proceed to the next instruction.
- 5 Get the number in A, add 1 to it and put it back in A.
- 6 Go and continue from instruction 3.
- 7 Stop.

The computer carries out the instructions in sequence until it reaches step 4. Step 4 asks the computer to jump to a new instruction (i.e. to stop) as a result of comparing two numbers. If the number in 'A' does not equal 9, the computer moves on to step 5. Step 6 tells it to jump back to instruction 3 regardless. In this way steps 3 to 6 are done repeatedly until the number in 'A' is equal to 9. As a result the numbers from 0 to 9 appear on the screen.

All programs, no matter what programming language they are written in, work along these lines. Complex programs are just vast collections of short instructions with vast numbers of operations, comparisons and jumps.



**Programming languages**

The example above is written in English to illustrate how a program works. To program a computer, there must be a way of communicating the instructions to the machine in a language it understands. This is done by using programming languages. Programming languages such as BASIC, Pascal and FORTRAN make it possible for people to write computer programs in near-human languages that are understood by both the programmer and the computer.

**HARDWARE AND SOFTWARE**

All computer systems can be divided into two basic parts: hardware and software.

**Hardware**

Hardware consists of the physical components of the system: the keyboard, mouse, plastic casing, wires, silicon chips, disc drives, and so on.

**Software**

Software is a set of programs, procedures and routines which cause the computer to carry out particular operations. Software is divided into two categories: operating system programs and applications programs.

The operating system is a collection of programs that directly control the hardware, keep track of where all data is located in the computer and perform various 'house keeping' functions within the computer. Two of the operating system programs used by Archimedes: the Machine Operating System (Arthur), and the Advanced Disc Filing System (ADFS) are discussed later in this chapter.

Applications programs are the programs which tell the computer to perform certain tasks such as word processing or playing a game.

## HOW DATA IS PROCESSED

Every personal computer designed for business or professional use has a way of collecting, storing and recalling data. To do so, five elements are involved. These are input, a central processing unit, memory, storage facilities, and output.

### **Input**

Input is the way data is put into the computer. For example, on the Archimedes this can be done by using the mouse or the keyboard.

When you position the mouse on an icon and press the appropriate button, you are giving the computer data which tells it to perform the function designated by that icon.

When you type at the keyboard, you are putting data into the computer.

### Central processing unit

The central processing unit is the 'brain' of the Archimedes. It is where data, instructions and information are directed and then routed by the central processing unit to other parts of the computer.

The Archimedes uses the ARM (Acorn Risc Machine), a very powerful central processing unit that is capable of executing over four million instructions per second.

### **Memory**

Every microcomputer must have a place where data (including instructions as to where data can be found and what to do with it) is stored. This is known as memory.

Memory, or storage space, is always limited in a microcomputer. The amount of storage space available is measured in bits, bytes, kilobytes and megabytes.

The smallest unit of measurement is called a bit (an abbreviation of binary digit). Eight bits make up one byte, and one byte is equal to one character or symbol. For example, the letter 'A' takes up one byte of storage space in the computer's memory,

as does the '£.' sign or the digit '1'. A kilobyte (written *as* Kbyte) is equal to 1024 bytes. A megabyte (written *as* Mbyte) *is* equal to approximately one million bytes. If the computer you are using is said to contain one Mbyte of memory, that means the equivalent of approximately one million characters or symbols can be stored in the computer's memory.

There are two kinds of computer memory: Random access memory (RAM) and Read only memory (ROM).

*Random access memory:* RAM *is* computer memory into which data can be written and from which data can be read at will. For example, when you start up the computer and insert the Welcome Disc, the computer reads the data on the Welcome Disc and sends it to RAM. The 0.5 Mbyte of memory found in the Archimedes 305 (or one Mbyte if you are using an Archimedes 310) refers to the amount of storage space available in RAM.

— *Note:* the act of transferring data from the Welcome Disc (or any other disc containing appropriate data) to the computer's RAM is known as loading or reading. The act of transferring data from RAM to the Welcome Disc (or any other disc) is known as saving or writing.

Data is stored in RAM as it is processed by the computer. For example, if you have installed a second floppy disc drive in the Archimedes and are transferring data from one disc to another, when the appropriate command is given the data is taken from the disc in the first drive, loaded into RAM, then saved on the disc in the second drive.

A problem with RAM, however, is that data stored in RAM *is* lost when the computer is turned off.

Another possible problem *is* that only a limited amount of RAM is available. While you are using the computer, many of the applications and system programs are held in RAM. If you need to use several applications, you can run out of memory space. A more permanent storage facility with greater memory capacity must therefore be provided.

*Read only memory*: ROM is computer memory in which data is stored permanently. It is similar to RAM except that while you can retrieve (read) information from ROM, you cannot change (write) information to it and data stored in ROM *is* not lost when the computer is turned off.

All data in ROM is put there by the manufacturer. The following are some examples of data contained in the Archimedes ROM:

— **The Machine Operating System (Arthur)**

This controls the overall operation of the computer. It is discussed later in this chapter.

— **BBC BASIC**

BASIC is an acronym for Beginner's All-purpose Symbolic Instruction Code, a programming language which is easy to learn and use. The User Guide discusses BBC BASIC in detail.

— **The Advanced Disc Filing System**

This is the filing system which controls the organisation of information on discs, making it possible for you to store and retrieve data easily. The ADFS is discussed later in this chapter and in greater detail in the User Guide.

**Storage facilities**

To overcome the problems of volatile RAM with limited storage space and ROM that cannot be changed, discs are provided. Discs store and maintain data magnetically rather than electronically. Magnetically stored data is not lost when the computer is turned off, and if you take care of discs you can store data on them indefinitely.

Discs work in conjunction with RAM. The information stored on a disc must be 'read' or 'loaded' into the computer's RAM. Once information is in RAM, you can add, delete, rearrange or do nothing to it. The changes you make are not permanent, however, until you save the information from RAM onto the disc.

Two kinds of discs are available for use with the Archimedes: floppy discs and hard discs.

*Floppy discs:* The Archimedes comes with a 3½ inch floppy disc drive already installed. The floppy discs you use with the computer can each store up to 800 Kbytes of information. As floppy discs are removable, when one is full you can insert another empty disc and hence store a large amount of data.

Whenever you want to look at the information stored on a floppy disc, you insert the disc in the drive and the computer loads some of the information contained on the floppy disc into the computer's RAM.

You can save any changes you have made, load data from another floppy disc into RAM, or remove the floppy disc and turn the computer off knowing the information you were working with is stored on the floppy disc and can be retrieved later.

*Hard discs:* Hard discs are magnetic discs similar to floppy discs but are enclosed in a sealed unit along with the disc drive. They have closer read/write head alignment (the mechanical device, similar to the record/playback head on a cassette recorder, which 'reads' the information on the disc) and denser storage capacity than floppy discs. They are therefore vulnerable to dust and must be permanently encased.

The advantages of using a hard disc rather than floppy discs are fast access to information and a large amount of storage space.

Hard discs typically hold from 20 Mbytes to 40 Mbytes of information. They also retrieve and store information much faster than floppy discs because of the fast rotational speed of the disc in the drive.

As with data stored on floppy discs, data on hard discs must also be loaded into the computer's RAM before you can manipulate it. Changes made to data in RAM must be saved onto the hard disc if you want to keep them.

## Output

Output is the way data is transferred from the computer's internal storage units to an output device. A monitor is an output device, displaying the results of a computer operation on a screen. A printer is an output device, making available a paper copy, sometimes referred to as 'hard' copy, of the information held in RAM. Another kind of output (as well as input) device is a modem, which allows you to send information over the telephone lines to another computer.

- *Note:* modem refers to MODulator-DEModulator. It is a device which allows data output by the computer to be translated into a form that can be carried over telephone lines. It is received by another modem at the other end which changes the data back to its original form so that it can be accepted by the computer receiving it as input.

## THE OPERATING SYSTEM

The Machine Operating System is a group of programs which comes with the computer and is stored in ROM. It controls the hardware: the monitor, keyboard, printer, memory and central processing unit. It keeps track of where all system programs and data are located, and controls the overall operations of the Archimedes.

For the operating system to work effectively, there has to be a way for you to communicate with it; you need to give it commands, and the operating system needs to report back to you. For example, you need to be able to tell it to load data from a disc, and if an error occurs it must be able to send a message telling you what happened, or let you know when it is waiting for another command.

There are two ways to communicate with the operating system: through the desktop, and through typed commands.

*Through the desktop:* some actions selected by pointing and clicking are translated into operating system commands.

*Through typed operating system commands:* you can use the keyboard to type commands which are understood by the operating system. To do so, you must follow specific rules understood by the operating system that govern the way you enter operating system commands.

For information on how to type operating system commands and the rules pertaining to them, see the **User Guide**.

## THE ADVANCED DISC FILING SYSTEM

Discs must be organised in such a way that the computer can find, change, delete, and store data so that it can be easily found again. This is done by the Advanced Disc Filing System (ADFS) program which is stored in ROM.

Parts of ADFS are the tools you use to perform administrative tasks, such as displaying the contents of a floppy disc, changing, deleting and saving information, formatting discs, and so on.

For example, when you save data onto a disc, the ADFS does the following:

- Finds free space on the disc big enough to contain your information.
- Moves the disc drive's read/write head accurately to the free space.
- Transfers a copy of your data from the computer's RAM to the disc.
- Notes where your data is stored so that it can easily be found again.

The ADFS organises data in a hierarchical file structure. The hierarchical structure is explained in the Welcome Suite ADFS tutorial. Work through the tutorial to understand how the structure works. It will help you organise your own data when you create and save it on a disc.

You can communicate with the ADFS either through the desktop or through typed ADFS commands (as you can with the operating system). ADFS commands and how to use the ADFS are discussed in the **User Guide**.





# HARD DISC FORMATTING

The hard disc formatting program `WFORM` is a BASIC program supplied on your hard disc in the directory `$.Library`. You should also keep a backup copy of `WFORM` on a floppy disc.

- **CAUTION:** formatting your hard disc will destroy all data stored on the hard disc. Ensure that before formatting the hard disc you have made a backup copy onto floppy disc of any data that you wish to keep. Information on copying files from hard to floppy disc is given in the chapter, **MANAGING DISCS**.

The `WFORM` program can be run from either the desktop or BASIC. To load and run from BASIC, exit the desktop, enter BASIC and `CHAIN "WFORM"`. To load and run from the desktop, double-click **select** on the `WFORM` option in the `Library` directory.

`WFORM` will prompt you for various parameter values as follows:

- *Note:* default values for the parameters are given when you run `WFORM`. These default values are appropriate for the internal hard disc supplied as standard in an Archimedes 440 and with the hard disc upgrades supplied by Acorn for fitting to other computers in the Archimedes series.

Press [Return] to confirm each value.

- 1 Format which drive ( 4 or 5 ) ? 4 [Return]  
d = 4 for the standard internal hard disc drive  
d = 5 for the external (second) hard disc drive (if fitted)
- 2 Sectors per track? 32 [Return]
- 3 Heads? 4 [Return]  
maximum value = 8
- 4 Cylinders? 615 [Return]

- 5 Low current cylinder? 1023 [Return]
- 6 Precompensation cylinder? 1023 [Return]
- 7 Parking cylinder? 663 [Return]

These default values are suited to the TANDON model TM362 as normally installed in the Archimedes 440 and supplied by Acorn as an upgrade to other computers in the Archimedes series. Any other drive types (eg an external drive) may require different parameters to be specified. Consult your supplier for further information on the required parameters.

WFORM will now list the current defects (if any) in the defect list and invites you to change the list. You may wish to add a new defect because the ADFS had previously returned an error message, eg `Disc error 10 at :4/00831E00`.

You can use the logical address directly in WFORM by selecting option C.

- *Note:* if you are adding more than one defect by logical address, you must add them in descending order of magnitude. You must also complete the entry of any or all logical address defects before adding any defect by (physical) cylinder, head and sector address, ie by option B.

Option B is normally only used to establish an initial defect list on a brand new, previously unformatted disc. In this case, the defect list is copied into the WFORM program from the written defect list that is stuck to the body of the drive mechanism. It would also be necessary to use option B to re-establish the defect list in the unlikely event that it has been corrupted, eg due to a power failure during a previous format operation. It would be necessary under these circumstances to remove the top cover of the Archimedes to gain access to the written defect list stuck to the body of the internal drive. Instructions for removing the Archimedes top cover are given in the section **How to change the internal batteries**, in the chapter TAKING CARE OF YOUR COMPUTER.

Select option A when the changes are complete.

Confirm your intention to format the disc by typing Y [Return]

WFORM now formats and verifies the hard disc drive. If the verification process detects any additional defects, you can add them to the defect list by confirming with Y [Return] when prompted. WFORM will then repeat the formatting and verification process in order to include the new defects.



- active line 55
- ADFS 149
- ADFSdemo 44
- adjust 18
- Advanced Disc Filing System 143, 149
- Analogue RGB 9
- anti-aliasing 47, 60
- applications programs 143
- Apps 39, 48
- Archimedes 300 30
- Archimedes 440 5, 7, 17, 37, 130, 151, 152
- arcs, drawing 88
- area 89
- ARM (Acorn Risc Machine) 144
- Arm Paint 80
- Arthur 43
- Back icon 25
- back of the computer 8
- backing up a disc 101
- backup, making 97
- backup procedure 101
- batteries, changing 119
- battery life 119
- battery nest location 120
- BBC BASIC 44, 146
- boundaries, of characters 51
- brush, in Paint 80
- brushes 83
- byte 14, 144
- Calculator 19
- calculator icon 36
- calculator icon which appears at the bottom of the desktop screen. 19
- Catalogue 76
- central processing unit 144
- Change window size 24
- Char full 49
- Char skel 50
- character 14
- Chorus only. 65
- circles, drawing 86
- cleaning the computer 114
- cleaning the mouse 114
- clear, in Paint 91
- Clef 68
- clef, choosing in Music Editor 68
- clicking 19
- clock icon 36
- colour monitor 12
- colours, changing 34
- colours, in Paint 95
- computer, cleaning 114
- computer, what it does 141
- configuring for printers 111
- Console 73, 75
- control keys 135
- conventions 3
- copy area 89
- copying a character 54
- copying files and directories 106
- copying from a hard disc 103
- curved lines, in font designer 54
- damage to computer 6
- data processing 144
- defect list, hard disc 152
- deleting a line 59
- deleting files and directories 108
- deleting notation, in Music Editor 74
- desktop 15 20

- desktop suite 27
- diary 16
- diary icon 32
- directories 39
  - copying 106
  - creating 105
  - deleting 108
  - moving 107
  - renaming 108
- Disc eject button 7
- disc icon 28, 38 Disc insertion slot 7
- double-clicking 19
- double percussion option, in Music Editor 66
- double-sided, double-density 125
- dragging 22
- draw 81
- drawing
  - arcs 88
  - circles 86
  - ellipses 86
  - freehand lines 82
  - parallelograms 85
  - rectangles 84
  - sectors 88
  - segments 87
  - squares 84
  - text 89
  - triangles 85
- drawing board 80
  
- Econet 10
- ellipses, drawing 86
- exit icon 37
  
- fan filter changing 123
  
- file 39
- file information 109
- file manager 105
  - copying 106
  - deleting 108
  - moving 107
  - renaming 108
- fill, in Paint 92
- floating point emulator 44
- Floppy disc indicator light 7
- floppy disc, parts of 125
- floppy discs 147
  - care of 126
  - inserting and removing 128
  - labelling 130
  - write protecting 129
- folder 39
- Font Alias 39
- Font Designer 39, 47
- font designer, accessing 48
- font, saving 53
- Fonts 40
- FORMAT command 98
- formatting
  - floppy discs 97
  - 640 Kbyte discs 101
- formatting from the desktop 98
- formatting from the keyboard 99
- Forward 72
- FPEmulator 44
- front of the computer 7
- Full screen 23
- full screen size 27
- func 81
- function key strip 11
- function keys 138

- Game 41
- GameCode 41
  
- hard discs 10, 16, 147
  - backing up 103 care of 130
  - drive indicator light 7
  - formatting 151
  - icon 28
- hardware 143
- headphones 14
  - connecting 13
- Headphones 32 ohm 9
- high-resolution monitor 123
  
- icons 27, 43
- Icons to Names, changing 109
- IEC 320 outlet 10
- input 144
- Instrument menu 67
- italic text 3
- key, assigning, in Music Editor 69
- Key menu, in Music Editor 69
- key signature, in Music Editor 69
- \*KEY 138
- keyboard 11, 12, 133
- keyboard cable 11
- Keyboard connector 7
- Keyboard only 65 keys
  - control 135
  - function 138
- numeric pad 139
- KeyTutor 44
  
- Library 43
  
- line, deleting 59
- loading a drawing 92
- loading music 77
  
- Machine Operating System (Arthur)
  - 143, 146
- Maestro menu 68, 71
- main desktop 27
- main desktop screen 16
- Mains inlet 10
- mains lead 12
- Master Compact, compatibility with 98
- memory 144
- menus 15, 18, 25
- mode, in Paint 95
- modem 148
- Modules 43
- monitors 5, 10, 12
- Mono video 9
- monochrome monitor 12
- MOS 148
- mouse 12, 15, 18
  - buttons 3
  - cable 11
  - cleaning 114 move area 90
- moving files and directories 107
- music
  - playing 75
  - saving and recalling 76
  - transcribing 71
- Music Editor 39, 63
  
- Names information 109
- network 10
- network icon 37
- new pen, in Font Designer 53

notation, inserting 73  
 Note option 71  
 Note-Pad 16  
 Note-Pad icon 29  
 numeric keypad keys 139  
  
 On/off indicator light 7  
 Open 95  
 operating guidelines iv  
 operating system 43, 148  
 operating system programs 143  
 Other option 71  
 Oval 52  
  
 Paint 79  
 Painting 39  
 palette icon 34  
 parallel 9  
 parallel or serial 111  
 Parallel printer 9  
     connecting 13  
 parallelograms, drawing 85  
 parking the drive heads 10  
 patterns, in Paint 91  
 pen, creating in Font Designer 51  
 Pen menu 54  
 pen previously created, in Font Designer 53  
 pens 47  
 Play 75  
 playing music 75  
 plug connections iii  
 Podule Backplane panels 8  
 pointer 18  
 printer settings 111  
 printers, configuring for 111  
 programming languages 143  
  
 programs 141  
  
 Quit 25  
  
 RAM\_Basic 44  
 Random access memory (RAM) 145  
 Read only memory (ROM) 145  
 recalling music 76  
 rectangles, drawing 84  
 registration form 5  
 renaming files and directories 108  
 Repertoire, in Music Editor 76  
 reset procedure 123  
 reset switch 11  
 Rewind 73  
 roller ball 18  
 RS423 9, 14  
  
 saving a drawing 92  
 saving music 76  
 ScreenDemo 44  
 scroll up 24  
 scrolling a score 72  
 sectors, drawing 88  
 segments, drawing 87  
 select 18  
 serial 9  
 serial device  
     connecting 13  
 serif, creating 58  
 serifs 47  
 setting up 5  
 Setup menu 65  
 shapes 81  
 shapes, drawing 84  
 sharps or flats, in Music Editor 69  
 shuttle 42



- single percussion option, in Music Editor
  - 66
- skel 50
- skeleton characters 51
- software 143
- Space Bar 134
- sprite editor 45
- squares, drawing 84
- Sqr 52
- Stave menu 65
- staves, setting up in Music Editor 65
- Stop 76
- straight lines 48
- switching on 15
- SYNC 9
  
- tasks keys 133
- temperature, operating 113
- Tempo option 66
- text, typing 89
- Time 70
- time, establishing in Music Editor 70
- time signature, in Music Editor 70
- title bar 21
- tracks and sectors 97
- Transcribe 68
- Transcribe menu 71
- transcribing music 71
- triangles, drawing 85
  
- tutorial, accessing 45
- Tutorials 44
- typewriter keys 134
  
- user response form 5
- UserFonts 40
- UserPics 40
- UserTunes 40
- Utilities 45
  
- Vertical and horizontal scroll 23
- vertical scroll 24
- Voice and Keyboard 65
- Voice only 65
  
- Welcome Disc programs 37
- Welcome Suite 15, 27, 37
- Welcome Suite ADFS tutorial 149
- WFORM 151
- Whole font 54
- Whole font menu 48
- windows 15, 20
- write-protect 98
  
- Xor, OR, AND and INV 95
  
- 3½ inch floppy disc drive 7
- 65Arthur 43
- 75Ohm HI-RES MONITOR 0/P 9





Acorn 